

GIM

Gata Meble

od 1980

PL: INSTRUKCJA MONTAŻU

EN: ASSEMBLY MANUAL

CZ: PŘÍRUČKA PRO MONTÁŽ

SK: PRÍRUČKA PRE MONTÁŽ

DE: MONTAGEANLEITUNG

SR: UPUTSTVO ZA INSTALACIJU

NL: MONTAGE-INSTRUCTIES

17.11.2020 - Rev. 3

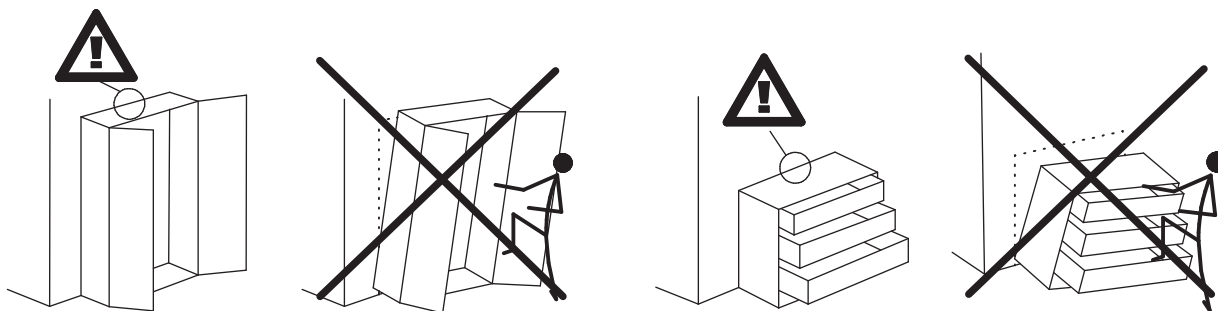

PL:

OSTRZEŻENIE PRZED WYWRÓCENIEM SIĘ

Produkt musi być na stałe przymocowany do ściany dołączonymi uchwytami, aby uniknąć śmiertelnego wypadku, gdy się przewróci. W pakiecie są tylko śruby pozwalające na przykręcenie uchwytów do produktu, które zapobiegają przewróceniu się produktu. Prosimy o skontaktowanie się ze specjalistycznym sklepem lub fachowcem w sprawie śrub lub kołków, które należy zastosować do danego typu ściany.

EN:

ANTI-TOPPLE WARNING!

This product has to be permanently fixed to the wall with the bracket(s) included, to avoid fatal injury in case it topples over. The pack only contains screws for fastening the anti-topple bracket(s) itself to the product. Please contact your DIY or hardware store for advice on the correct type of screws/raw plugs for your type of wall.

CZ:

VAROVÁNÍ TÝKAJÍCÍ SE SKLOPENÍ!

Tento výrobek musí být trvale připevněn na stěnu pomocí přiložených držáků, aby nedošlo ke smrtelnému zranění, kdyby se sklopil. Sada obsahuje pouze šroubky pro upevnění držáků zabráňujících sklopení k výrobku. Ohledně správného typu vrutů/hmoždinek pro daný typ stěny se obraťte na vhodný obchod nebo železářství.

SK:

VÝSTRAHA PRED PREVRÁTENÍM!

Tento produkt musí byť natrvalo pripevnený k stene pomocou dodanej(-ých) konzoly (konzol), aby sa predišlo smrtelnému úrazu v prípade, že sa prevráti. Balenie obsahuje iba skrutky, ktorými sa pripevňujú k produktu samotné konzoly chrániace pred prevrátením. Kontaktujte miestnu predajňu pre domácich majstrov alebo železiarstvo, kde vám poradia ohľadom správneho typu skrutiek/príchytiiek pre váš typ steny.

DE:

ACHTUNG KIPPGEFAHR!

Dieses Produkt muss mit der/den mitgelieferten Halterung(en) dauerhaft an der Wand befestigt werden, um tödliche Verletzungen im Falle eines Umkippens zu vermeiden. Die Verpackung enthält lediglich Schrauben zur Befestigung der Kippschutzhalterung(en) am Produkt. Für Informationen zur richtigen Schrauben-/Dübelart für Ihren Wandtyp wenden Sie sich bitte an Ihren Baumarkt.

SR:

UPOZORENJE O OPASNOSTI OD PADA!

Ovaj proizvod mora stalno da bude pričvršćen za zid držačem (držačima) iz pakovanja, da bi se izbegla smrtonosna povreda u slučaju da proizvod padne. Pakovanje sadrži samo šrafove za pričvršćavanje na proizvod držača protiv padanja. Kontaktirajte prodavnicu "Uradi sam" ili gvoždarsku radnju za savet o ispravnoj vrsti šrafova/tiplova za tip zida koji imate.

NL:

WAARSCHUWING KANTELBEVEILIGING!

Dit product moet met de haak/haken permanent bevestigd worden aan de muur om verwondingen met dodelijke afloop te voorkomen indien deze omkantelt. De verpakking bevat enkel schroeven om de haken voor kantelbeveiliging op het product vast te maken. Contacteer uw doe-het-zelfzaak of bouwmarkt voor advies over het correcte type schroeven/rawlplugs voor uw soort muur.

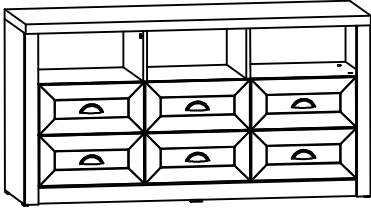

GM

Gata Meble

od 1980

INSTRUKCJA MONTAŻU / MOUNTING INSTRUCTIONS / MONTÁŽNÍ NÁVOD / NÁVOD NA MONTÁŽ / MONTAGEANWEISUNG

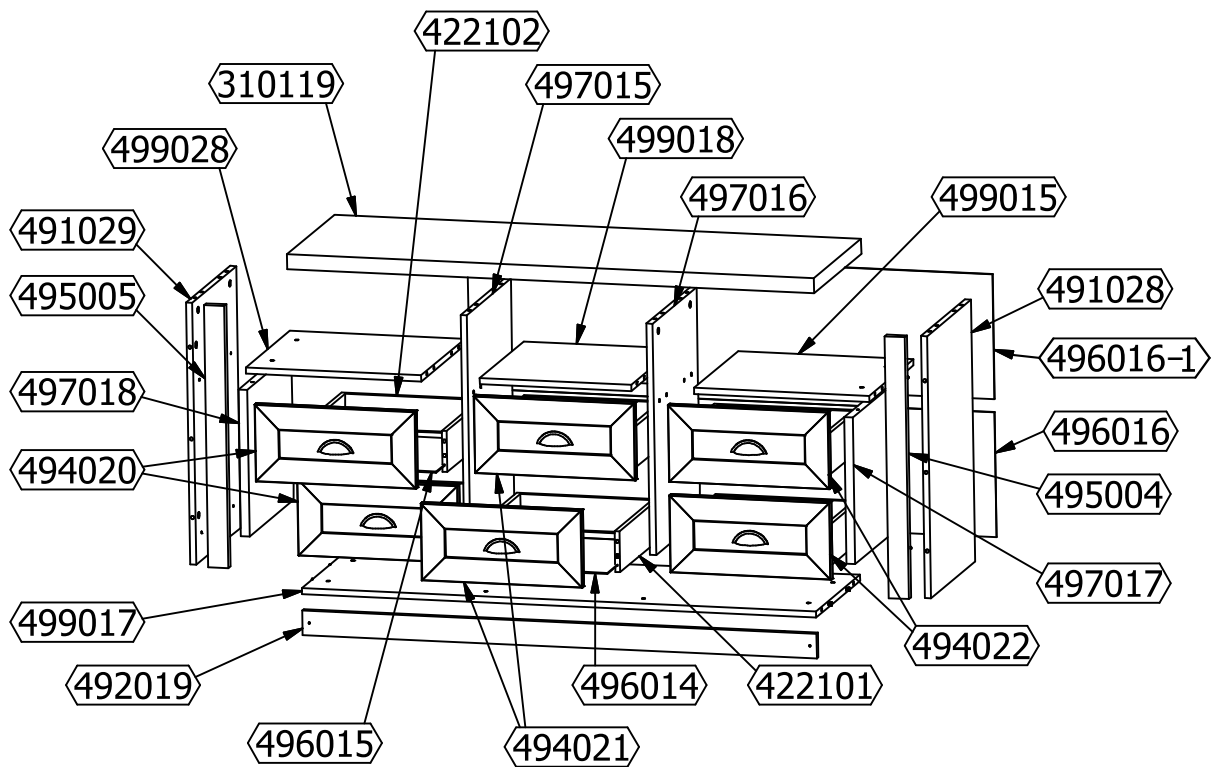

A x38

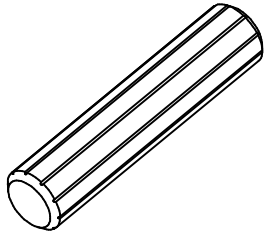

B x28

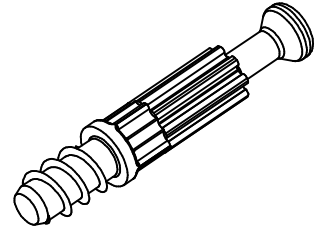

(8x36)

B1 x4

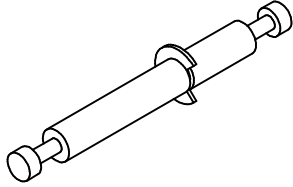

C x28

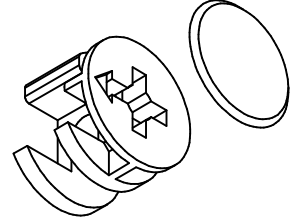

(15x12)

D x12

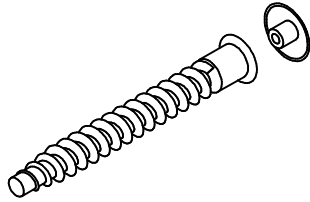

G x55

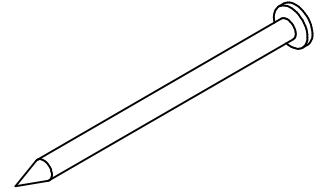

P x6

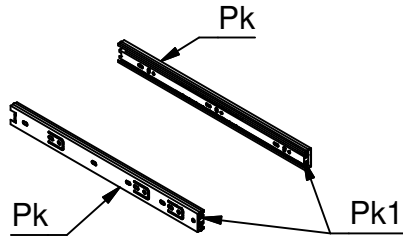

M1 x6

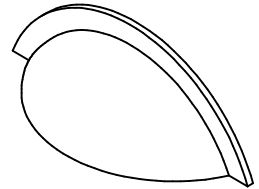

H x1

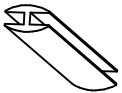

(1297 mm)

C1 x12

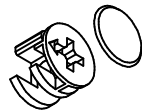

(12x10)

Sz x5

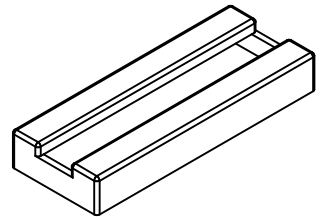

W1 x48



(3,5x13)

W4 x2

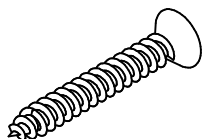

(4,0x30)

X7 x12



(M4x16)

Z x1

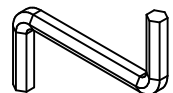

KROK 1

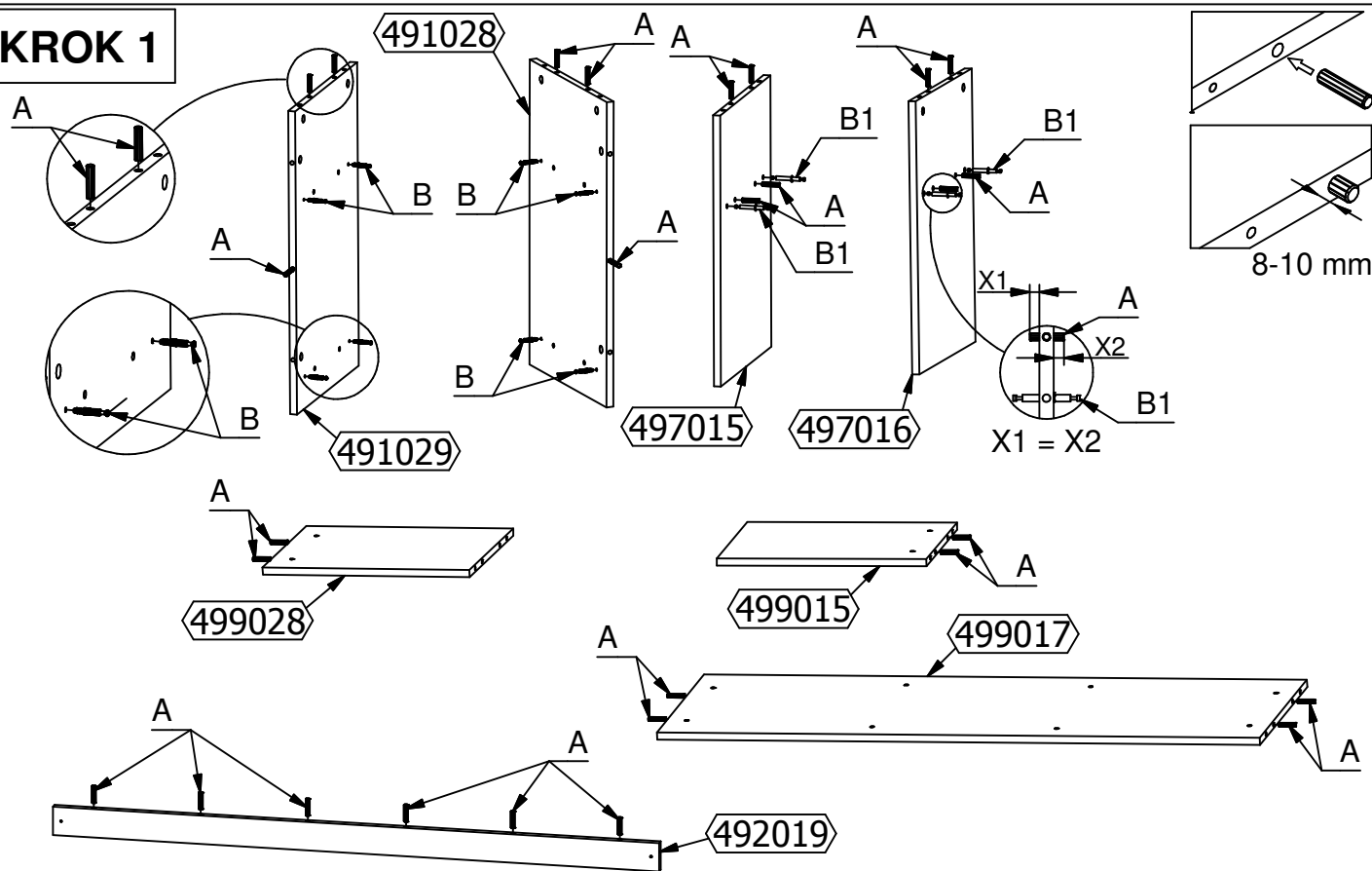

KROK 2

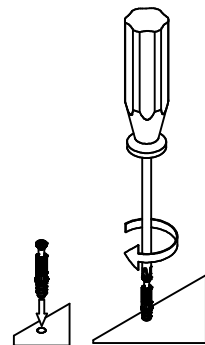
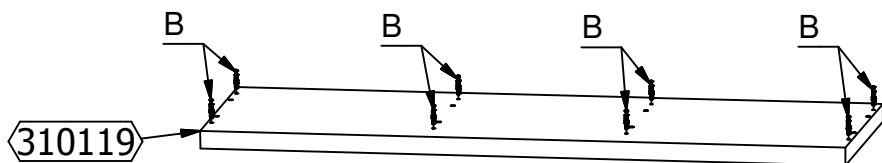

KROK 3

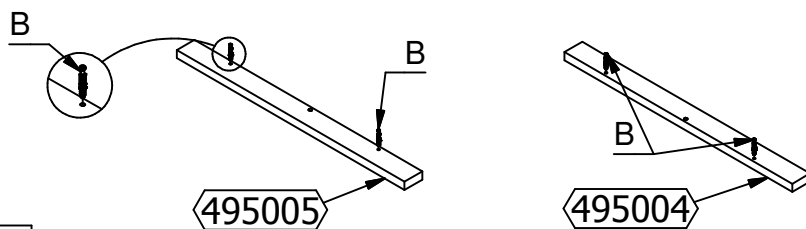

KROK 4

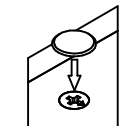
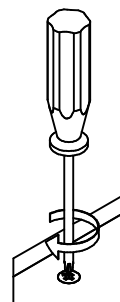
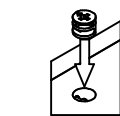
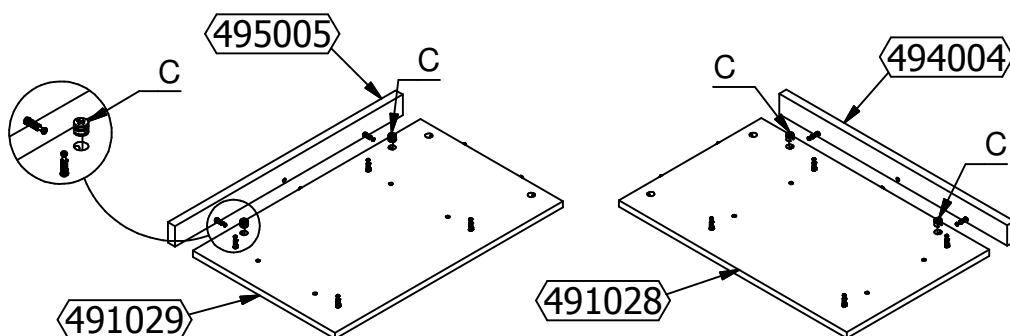

KROK 5

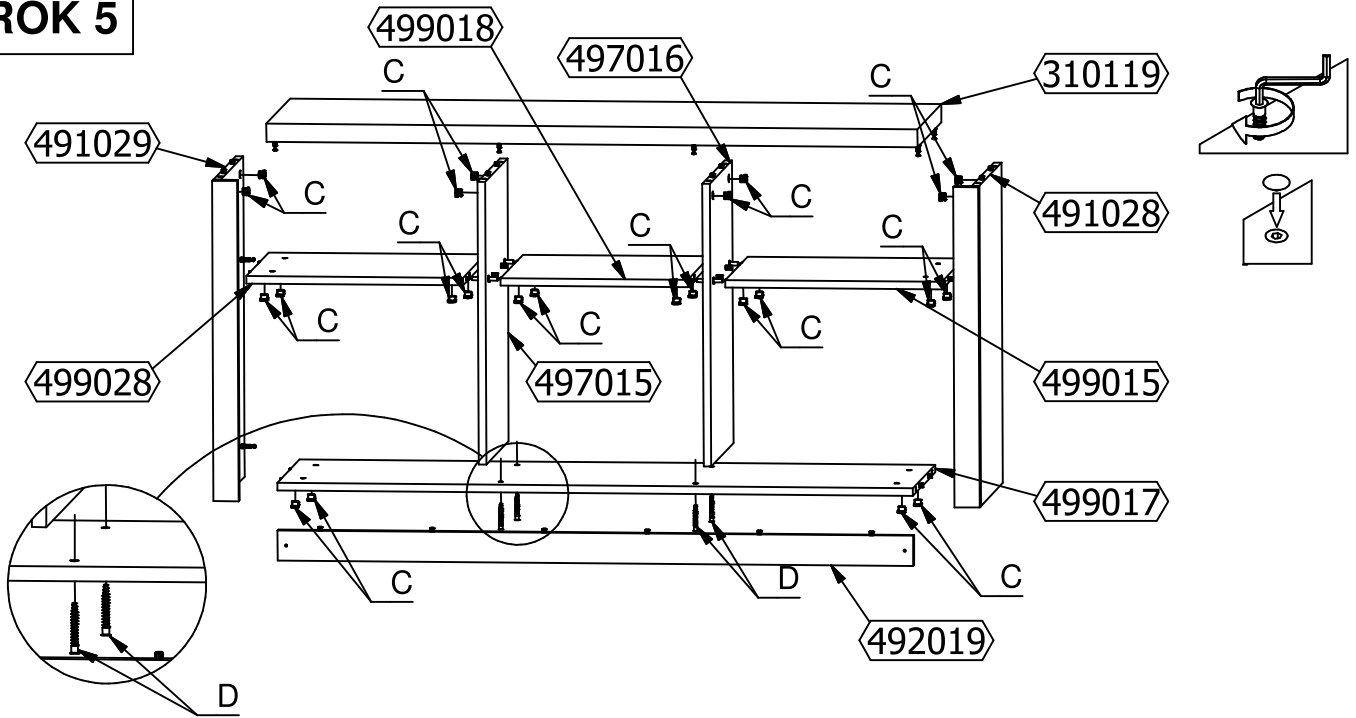

KROK 6

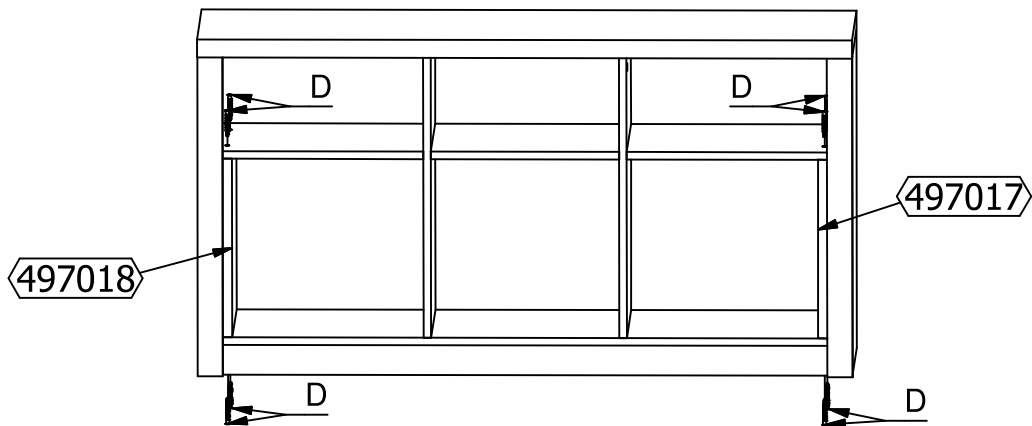

KROK 7

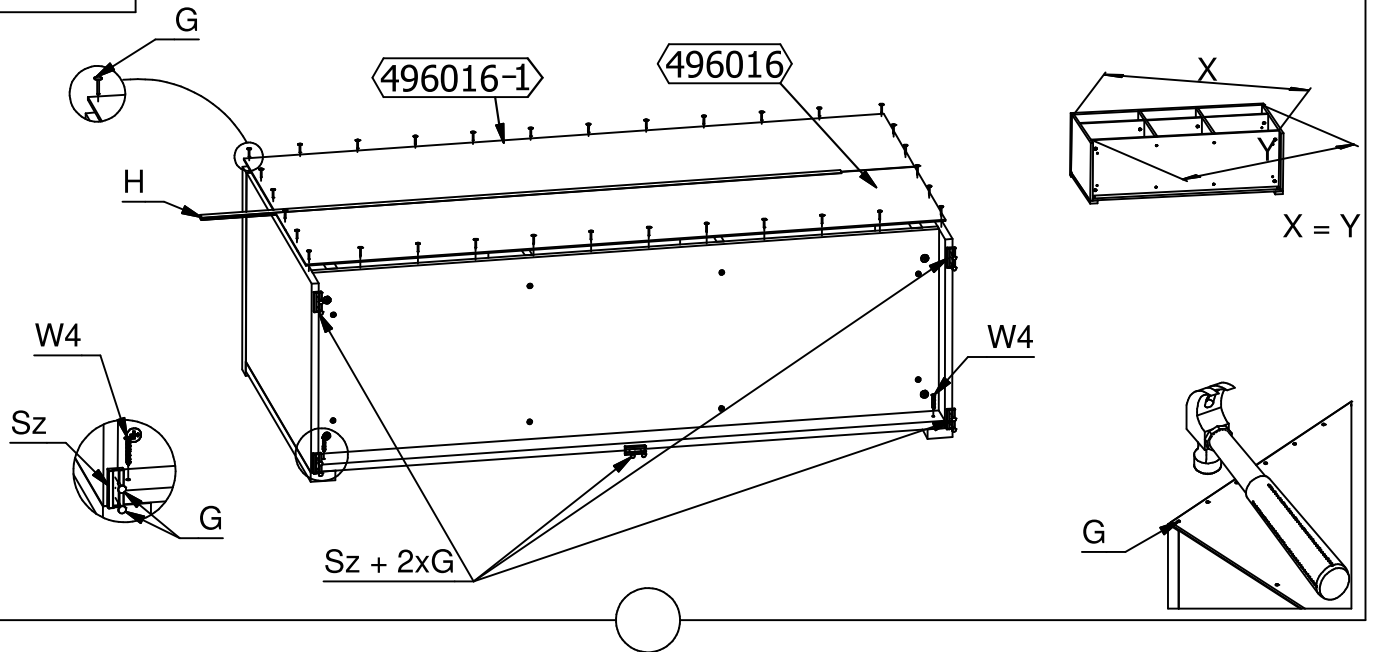

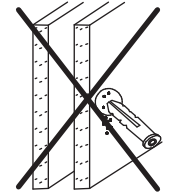
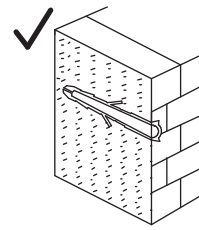
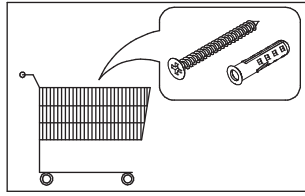
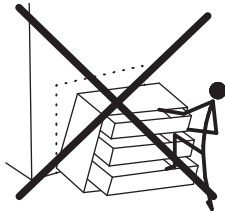
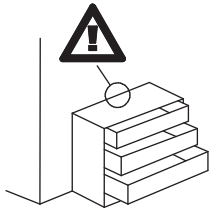

A

T4 x1

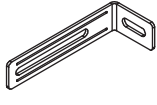

75x28x16 mm

W2 x2

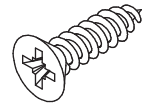

Ø3,5x16mm

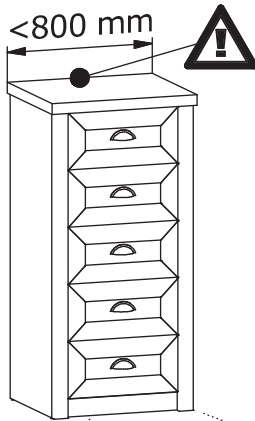

B

T4 x2

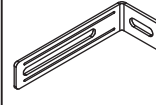

75x28x16 mm

W2 x4

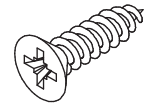

Ø3,5x16mm

