

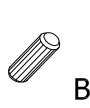

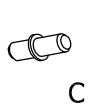

 A	 B	 C	 D
8	8	8	30
 E	 F	 K	 P
6	6	20	4
 L	 M	 N	 O
4	4	2	12

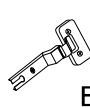

REGULACJA ZAWIAS

A - Ustawienie szczeliny między drzwiami, a frontową płaszczyzną boku lub przegrody. Połóżniczkę śrubę A, przesunąć drzwi w przód lub w tył. Po ustawieniu szczeliny dokręcić śrubę A.

B - Ustawienie szczeliny między drzwiami. Połóżniczkę śrubę B, przekręcić śrubę B w prawą stronę. Dokręcić śrubę A.

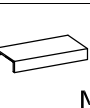
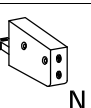
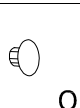
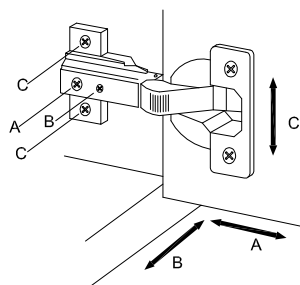
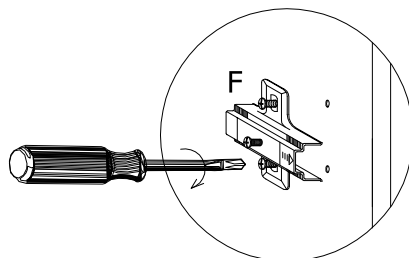
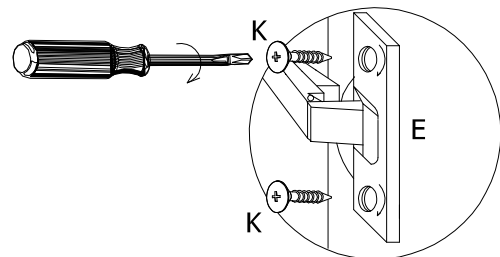
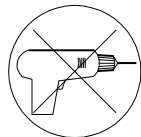
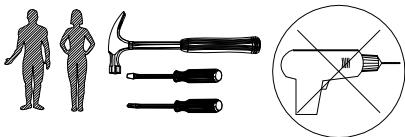
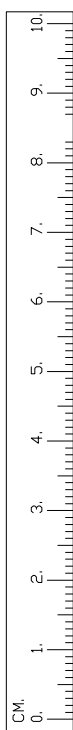
C - Ustawienie drzwi w pionie. Połóżniczkę śruby C. Przesunąć drzwi w górę lub w dół. Dokręcić śruby C.

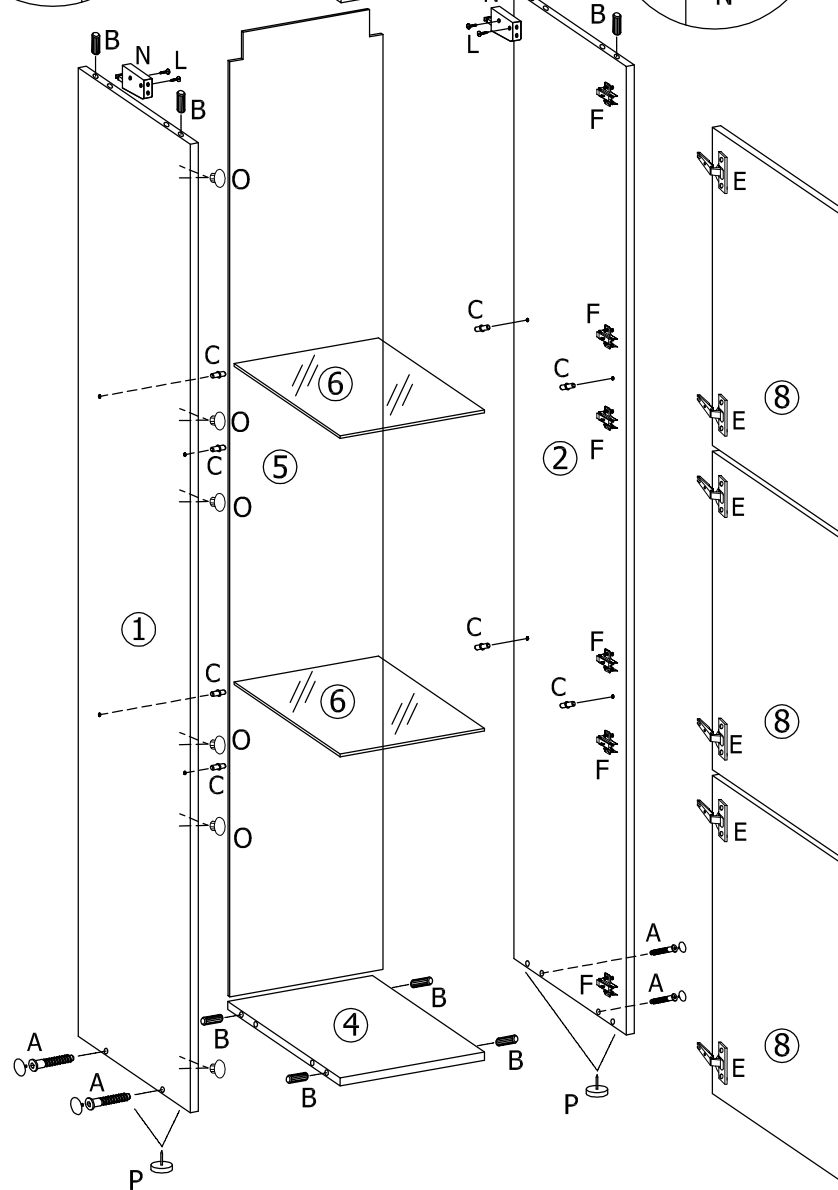
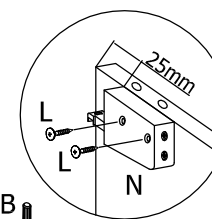
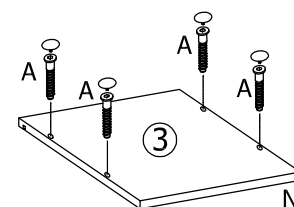
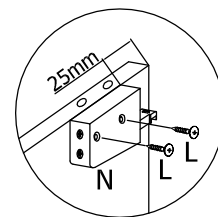
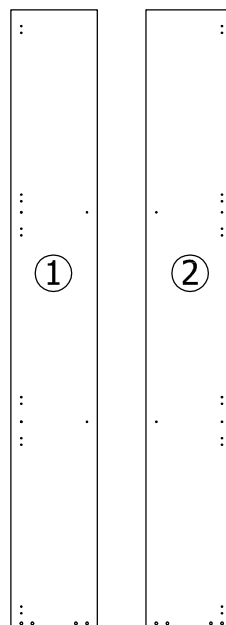

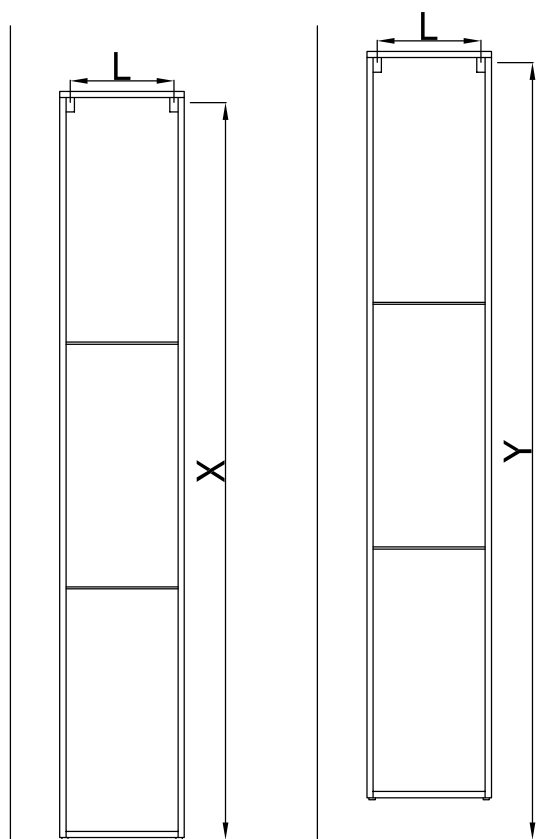
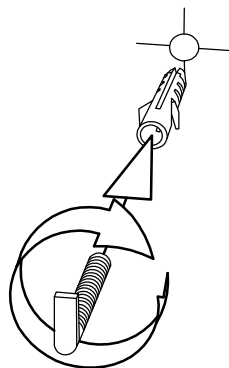
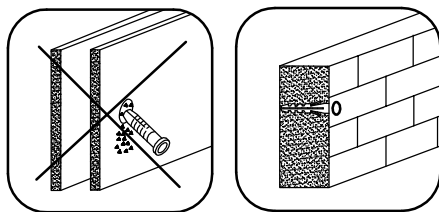
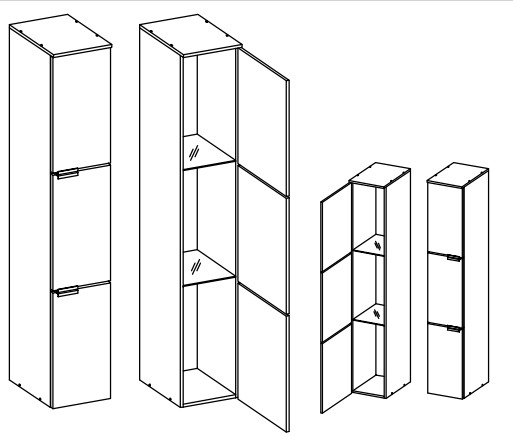

Uwaga:
Szafkę stojącą również
należy zawiesić na
zawieszkach aby
zabezpieczyć ją przed
przewróceniem

