











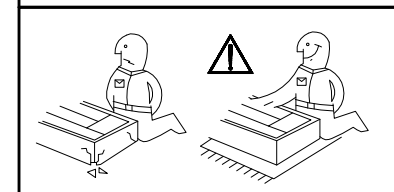

| | | | | | | | | | | | | |
|--|--|--|--|--|--|--|--|--|--|--|--|--|
|  |  |  |  |  |  |  |  |  |  |  |  |  |
| 8 | 8 | 8 | 1 | 2 | 4 | 10-15 | 8 | 4 | 4 | 8 | 2 | 4 |

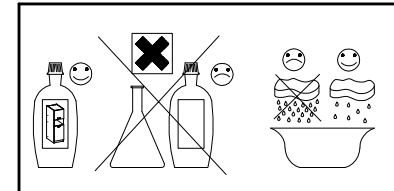
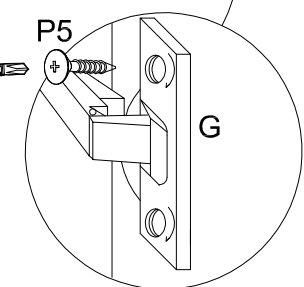
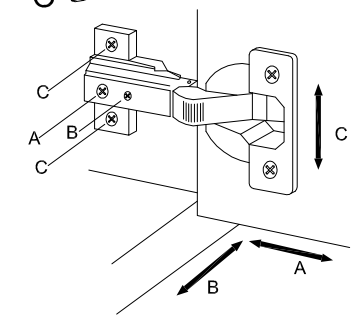
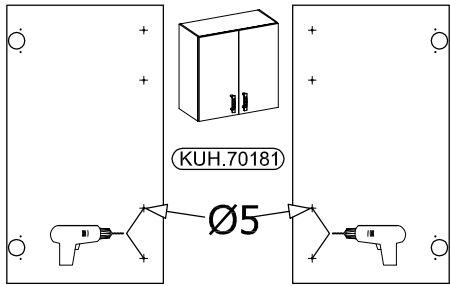
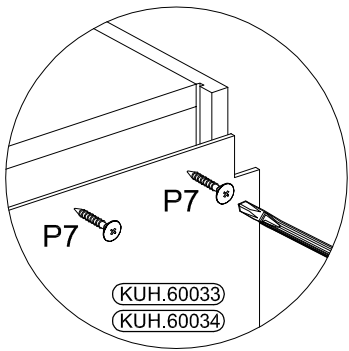
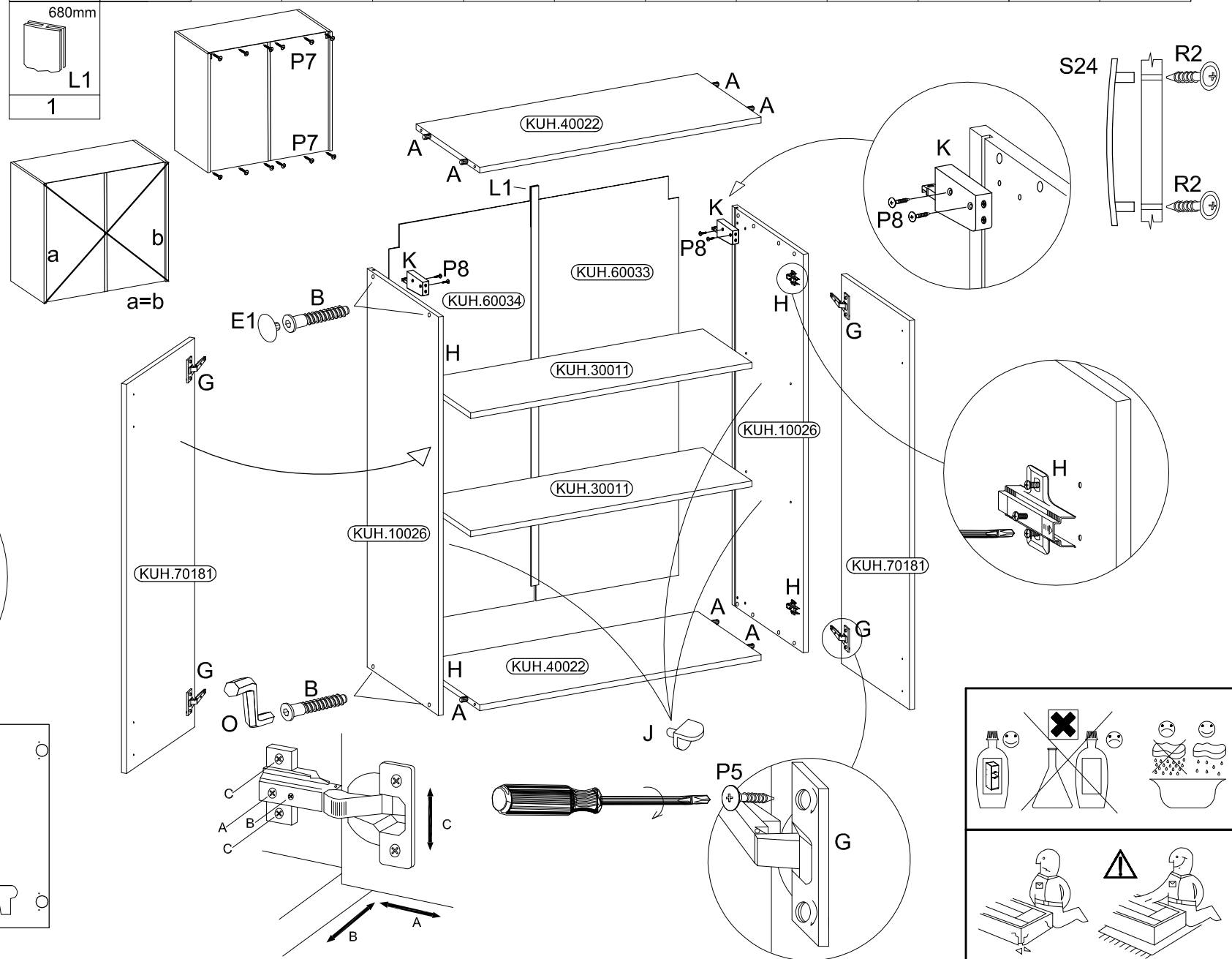
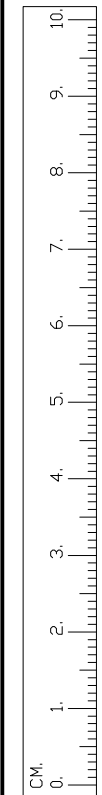
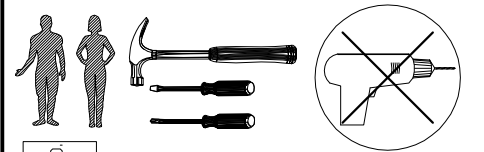
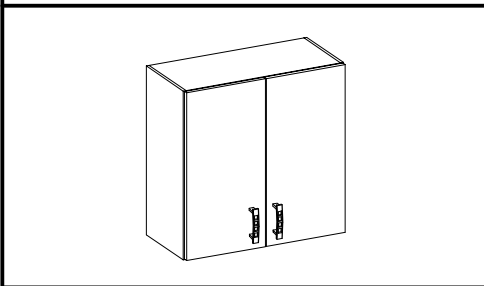

ISM-KUH-00154