

U x 3	T M4 x 23 x 3	F2 x 2	S4 4 x 16 x 10	N x 4	S5 3 x 20 x 16	
G x 16	S L-400 x 1 kpl.	Y 6,3 x 13 x 8	Z1 x 1 kpl.	T1 x 1 kpl.	H x 12	B x 12
A x 4	D 5 x 13 x 8	E x 4	L 6,3 x 13 x 8	F x 1	J 4 x 30 x 2	ZA x 12

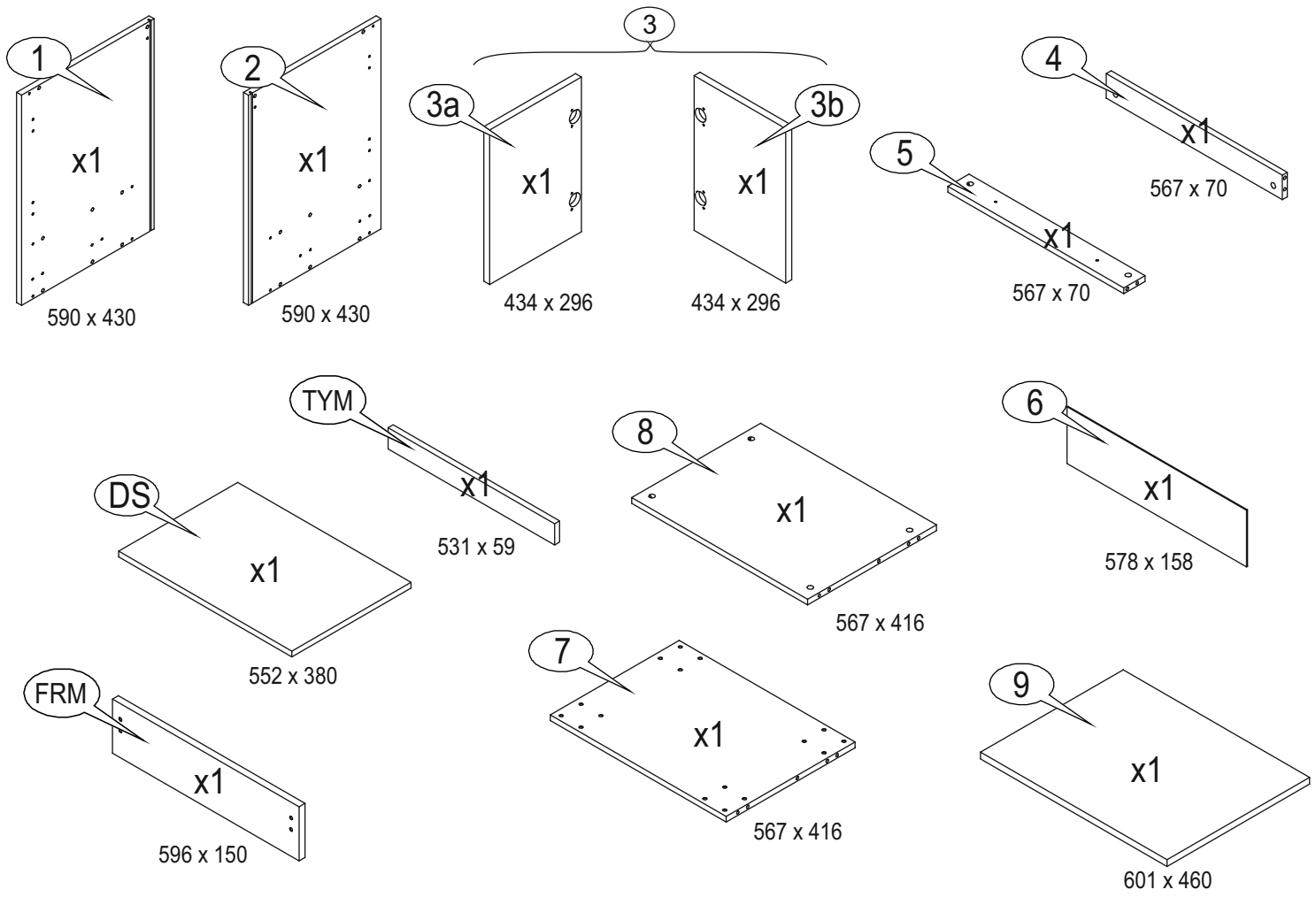

1

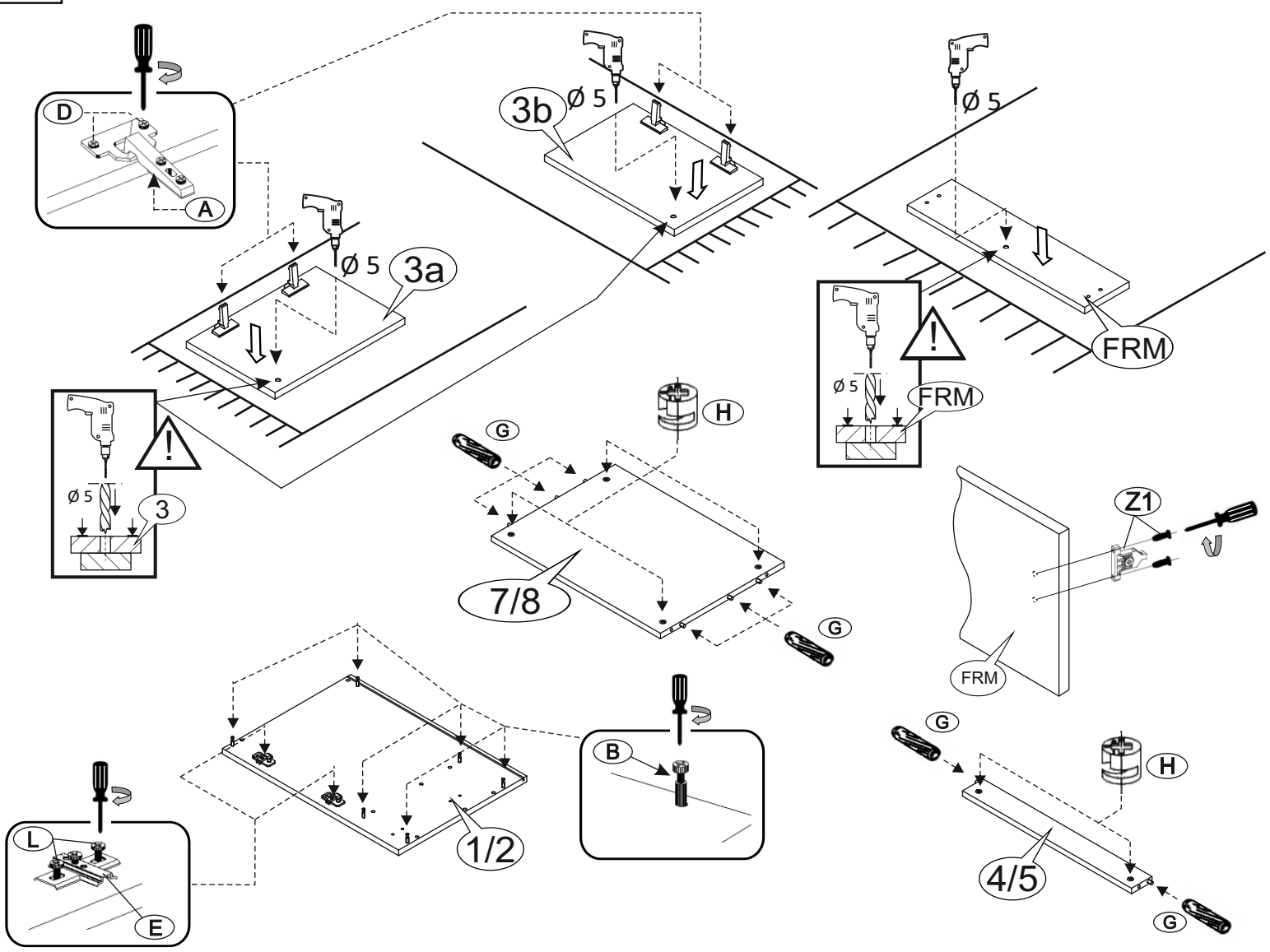

2

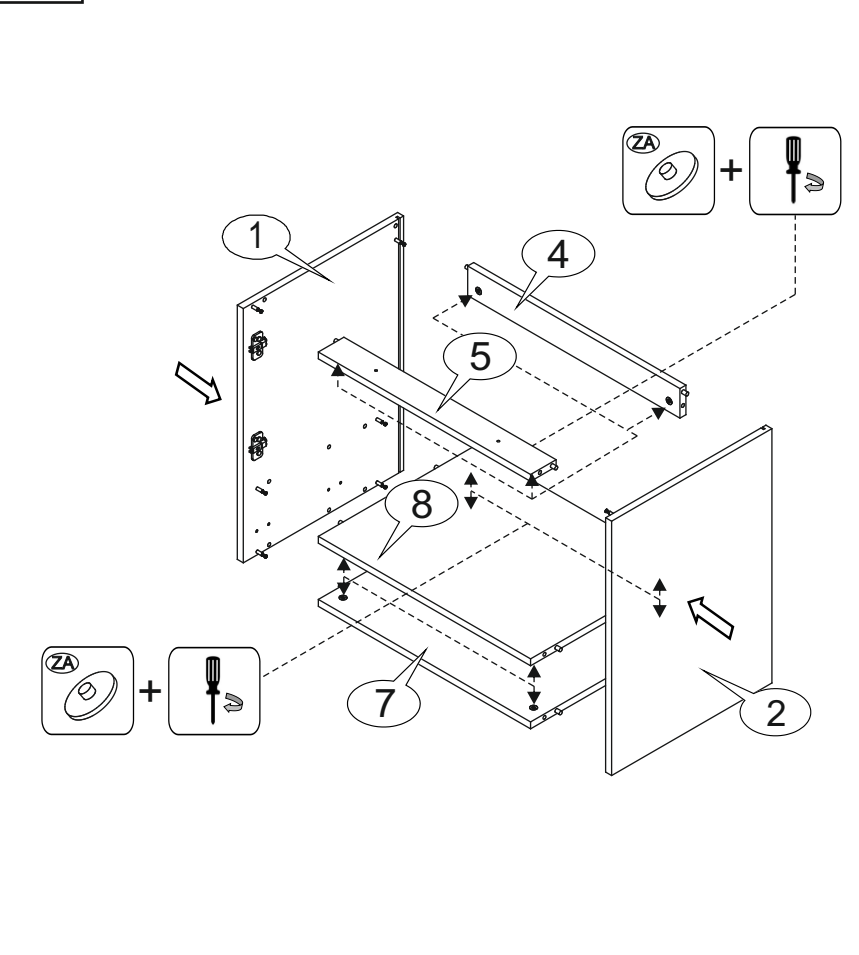

3

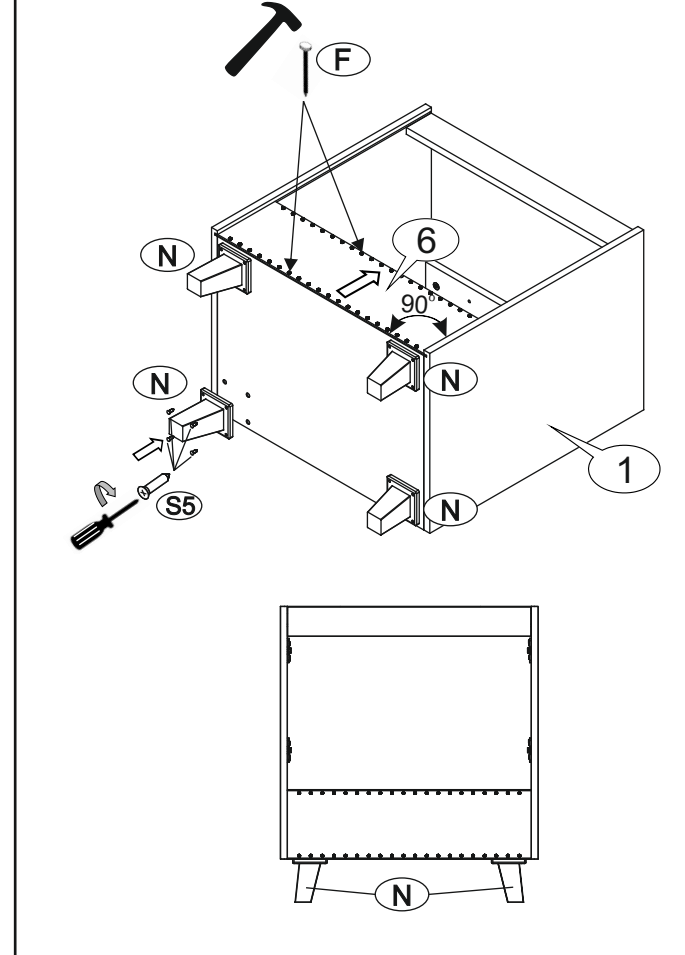

4

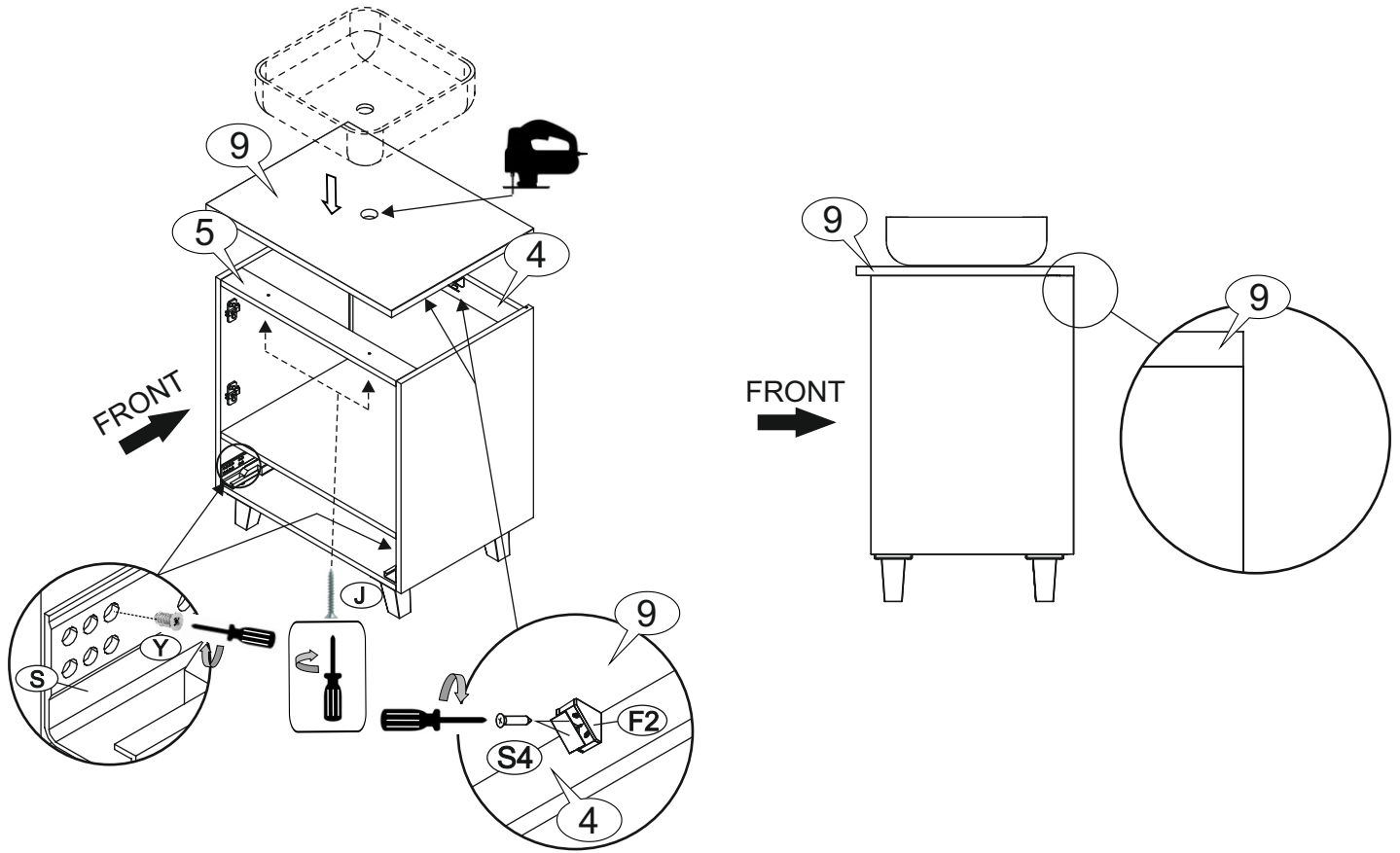

6

