

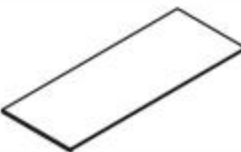

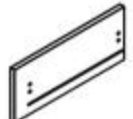

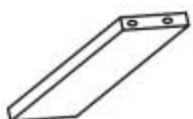

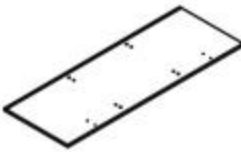

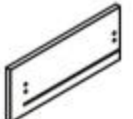

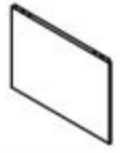

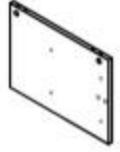











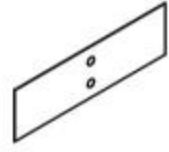







<b>A</b> ①		x1	<b>J</b> ⑩		x1	<b>V</b> ⑳		x4
<b>B</b> ②		x1	<b>K</b> ⑪		x1	<b>A</b>	<b>W</b> 	x36
<b>C</b> ③		x1	<b>L</b> ⑫		x1	<b>B</b>	<b>X</b> 	x36
<b>D</b> ④		x1	<b>M</b> ⑬		x1	<b>C</b>	<b>Y</b> 	x16
<b>E</b> ⑤		x1	<b>N</b> ⑭		x4	<b>D</b>	<b>Z</b> 	x4
<b>F</b> ⑥		x1	<b>O</b> ⑮		x4	<b>E</b>	<b>Z</b> <sub>1</sub>  4*35mm	x16
<b>G</b> ⑦		x2	<b>P</b> ⑯		x4	<b>F</b>	<b>Z</b> <sub>2</sub>  4*12mm	x44
<b>H</b> ⑧		x1	<b>Q</b> ⑰		x4	<b>G</b>	<b>Z</b> <sub>3</sub>  M6*12mm	x16
<b>I</b> ⑨		x1	<b>R</b> ⑱		x1	<b>H</b>	<b>Z</b> <sub>4</sub>  M6*50mm	x8
			<b>S</b> ⑲		x1	<b>I</b>	<b>Z</b> <sub>5</sub>  M6*25mm	x2
			<b>T</b> ⑳		x2	<b>J</b>	<b>Z</b> <sub>6</sub>  M6	x4
			<b>U</b> ㉑		x2	<b>K</b>	<b>Z</b> <sub>7</sub>  M6	x4
						<b>L</b>	<b>Z</b> <sub>8</sub>  M7*47mm	x4
						<b>M</b>	<b>Z</b> <sub>9</sub>  M6*12mm	x8
						<b>N</b>	<b>Z</b> <sub>10</sub> 	x2
						<b>Z</b> <sub>11</sub>		x8



1

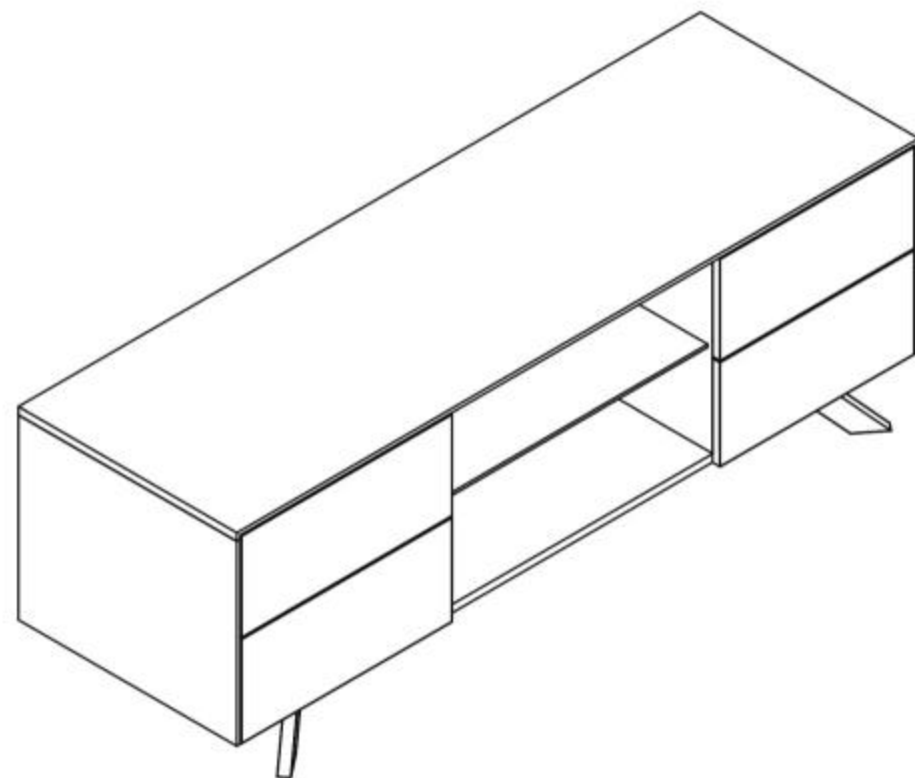
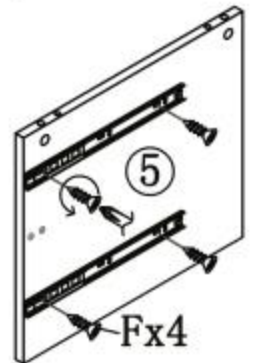
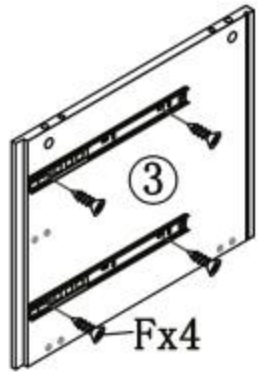
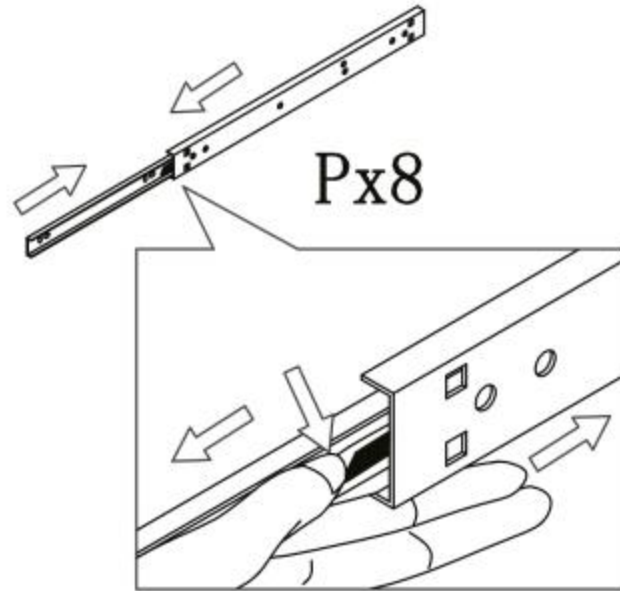

2

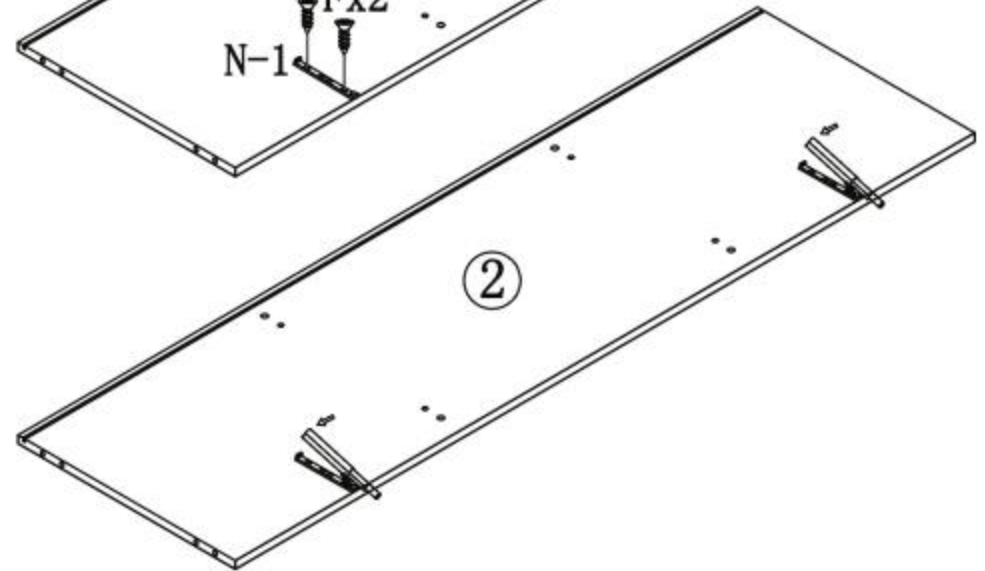
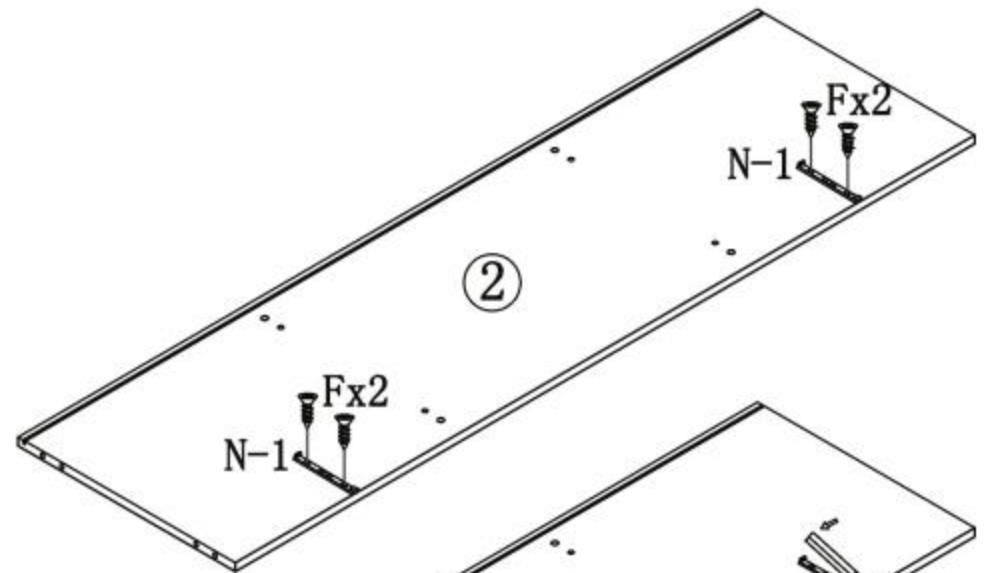
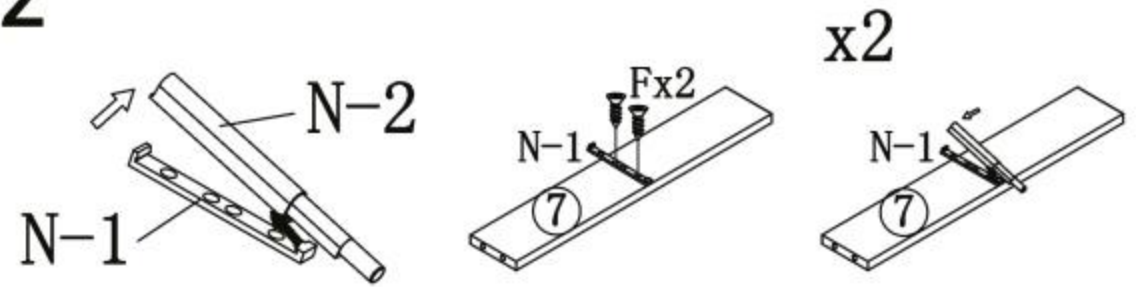



5

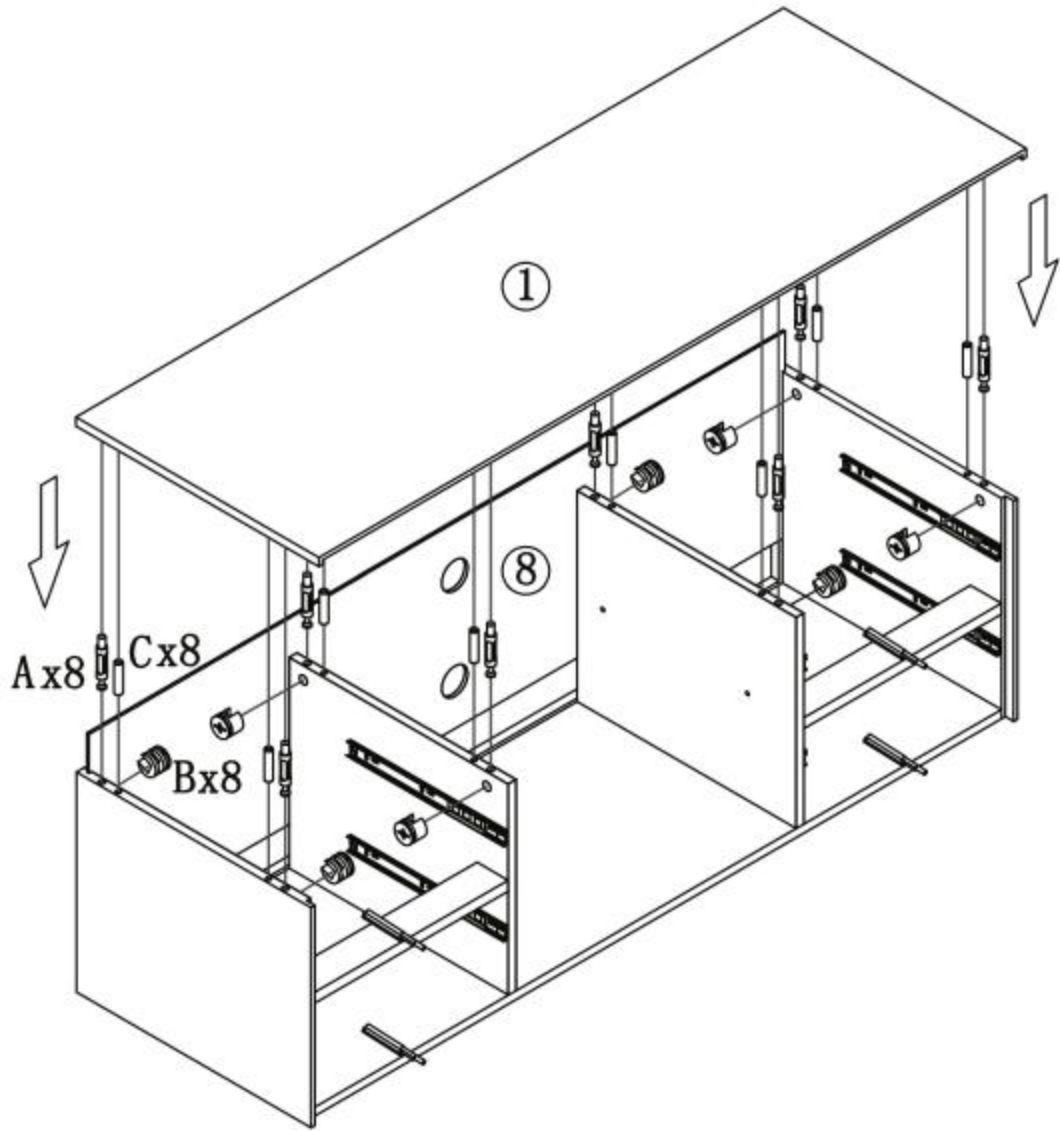

6

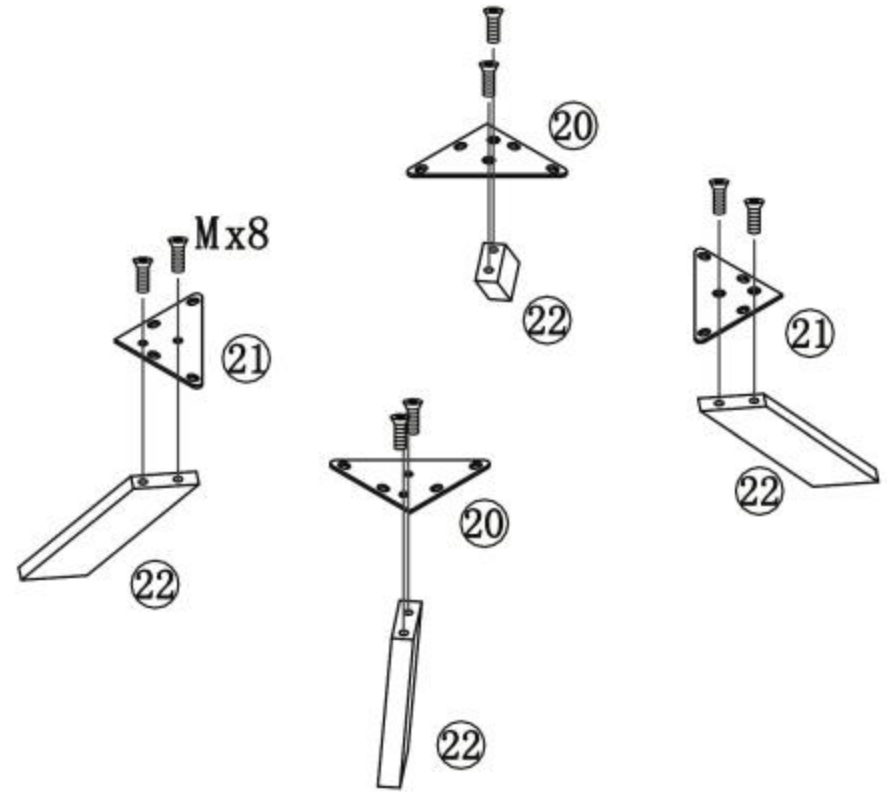

# 7

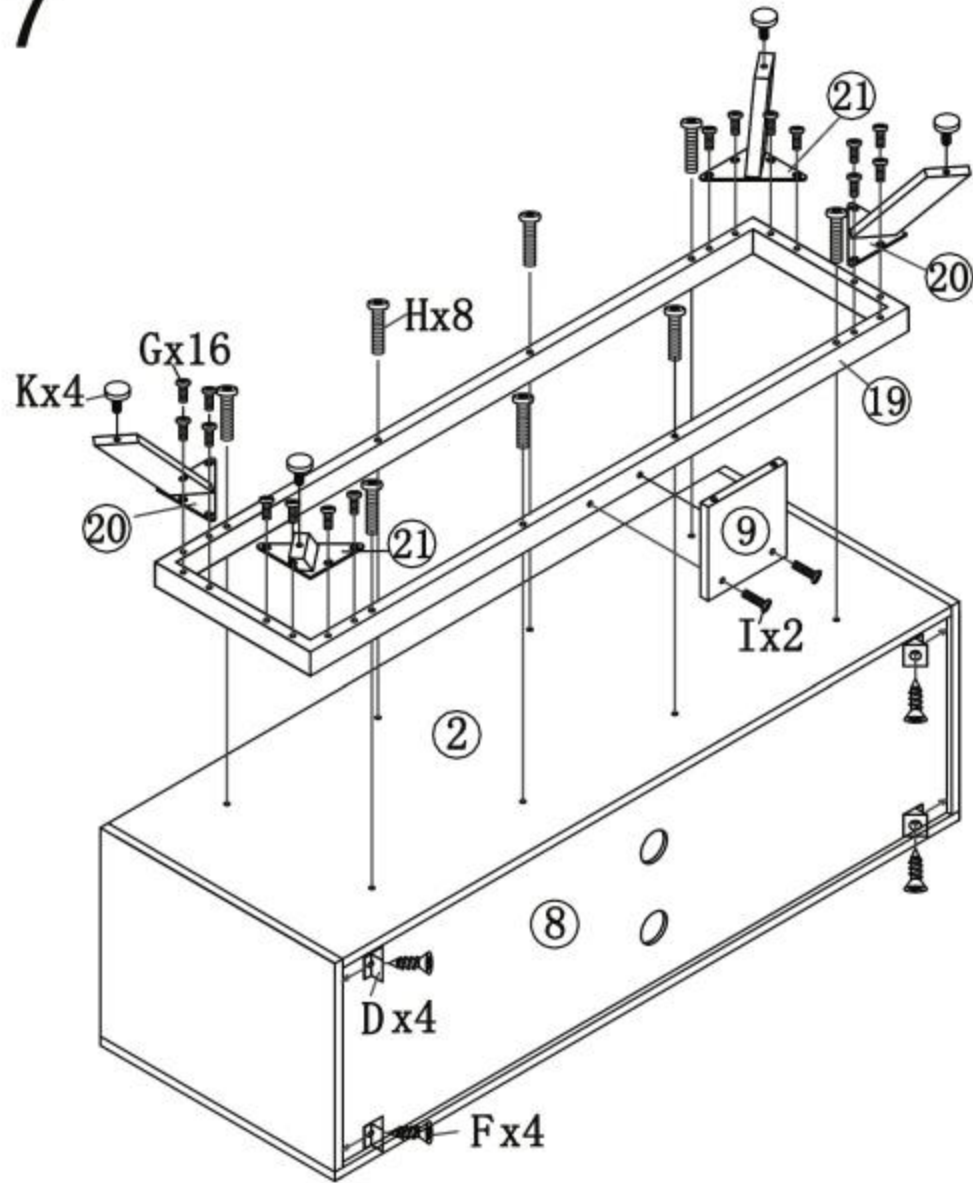

# 8

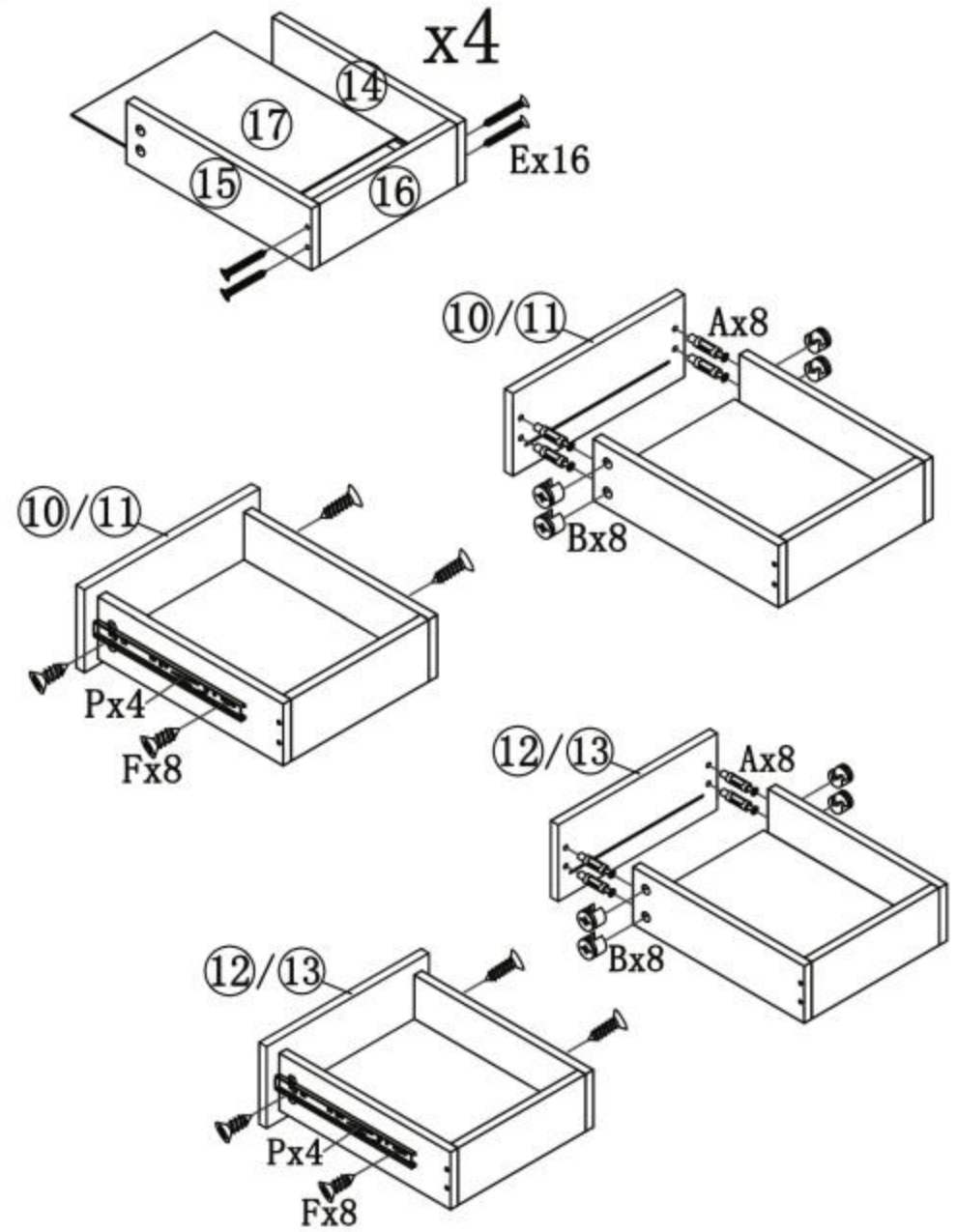

9

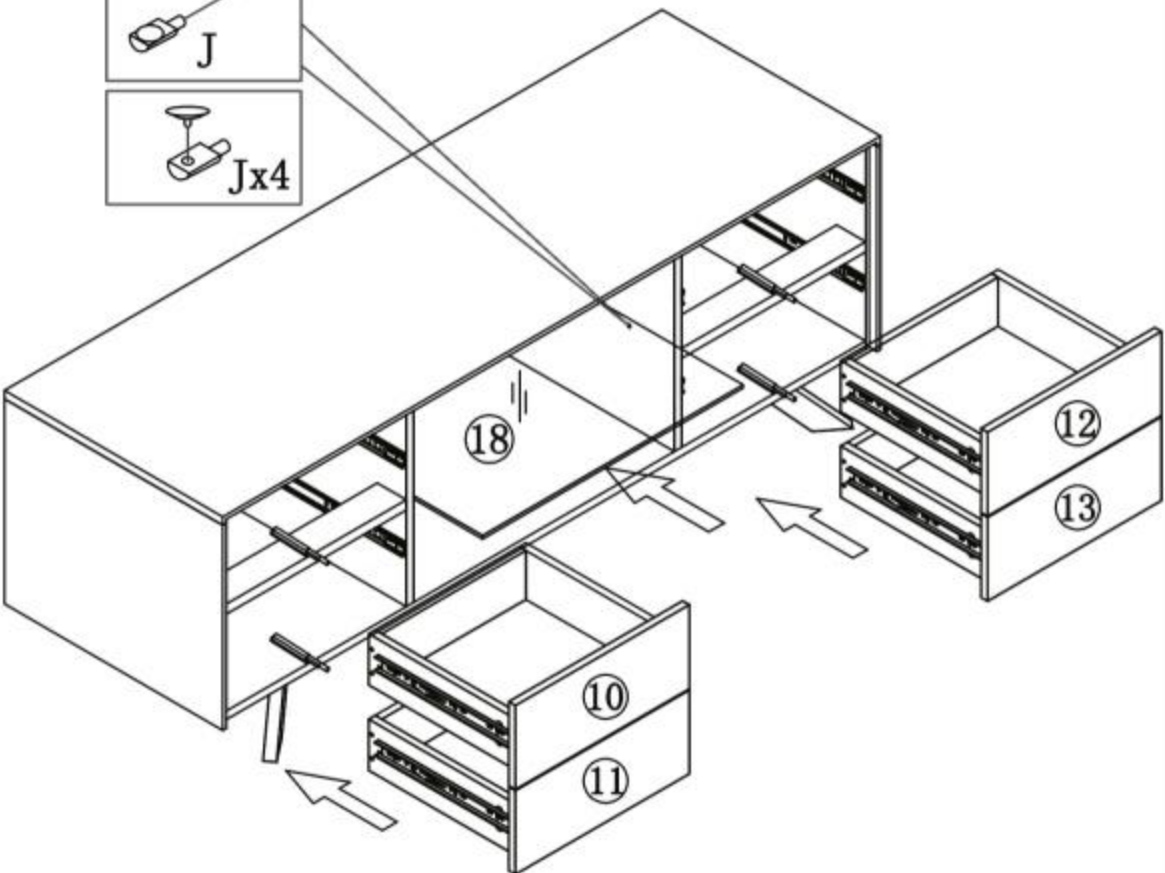
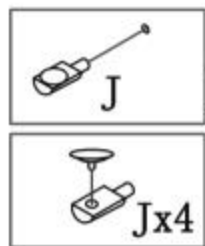

10

