

100

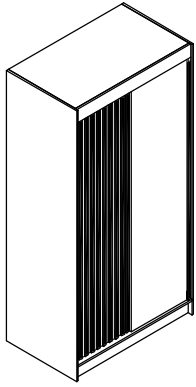

120

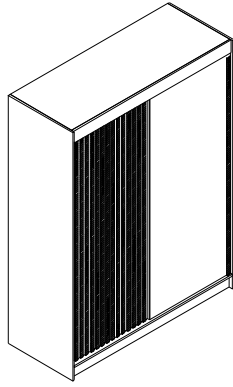

150

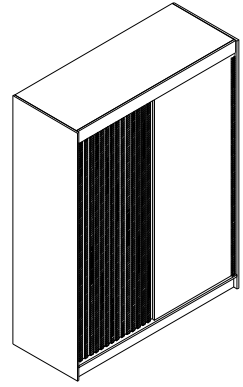

180

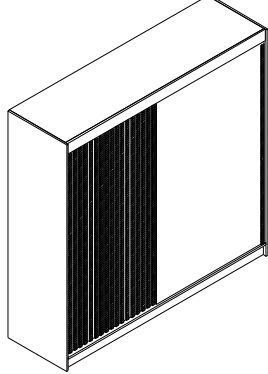

200

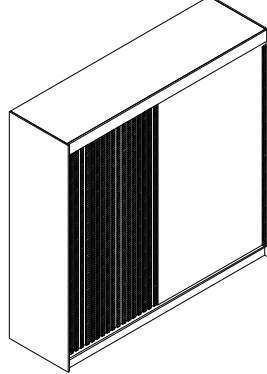

250

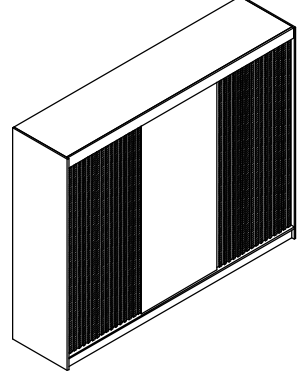

1



2

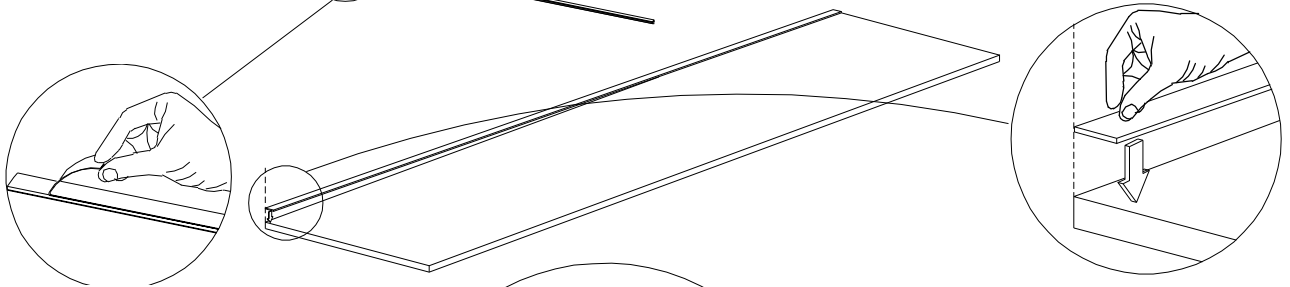

3

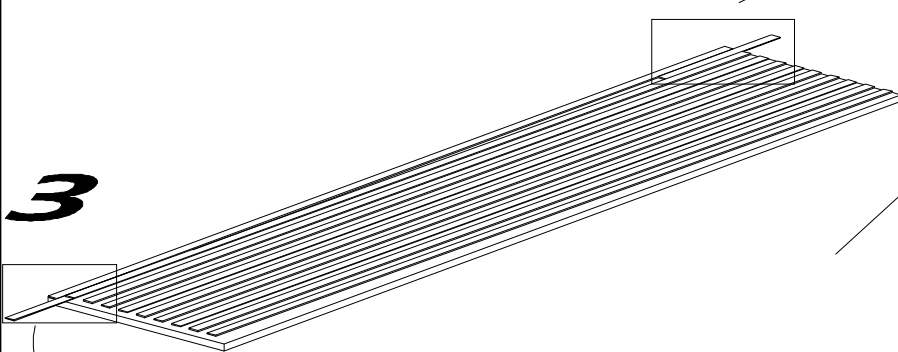

4

