

E10

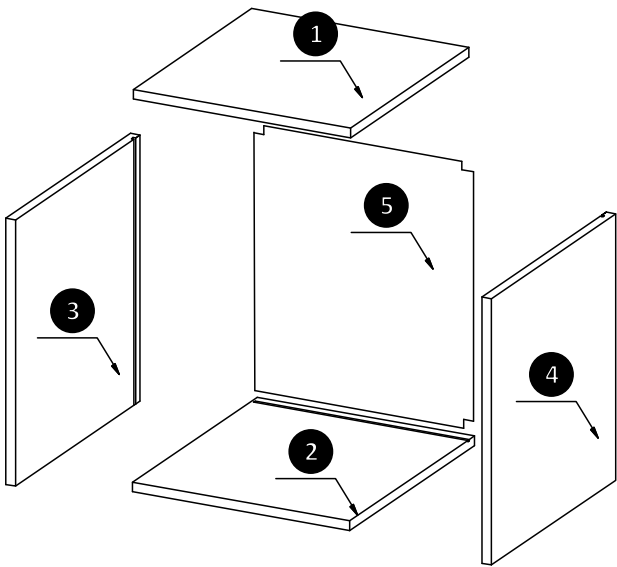

1	1	368	359	16
2	1	368	359	16
3	1	430	360	16
4	1	430	360	16
5	1	406	378	3

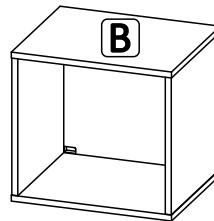
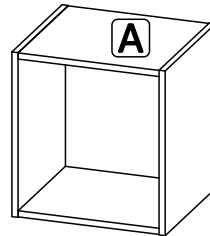

A0 8x30 8	C0 8	C2 8	C7 8	D0 3x15 4	D13 4x30 4	M1 4	P4 2
----------------------------	--------------------	--------------------	--------------------	----------------------------	-----------------------------	--------------------	--------------------

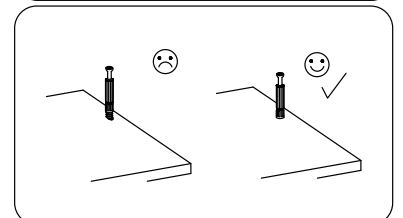
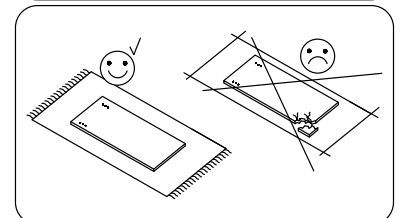
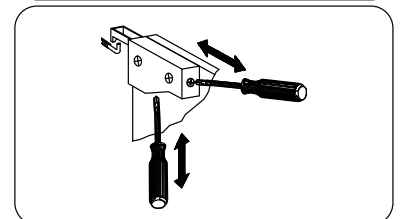
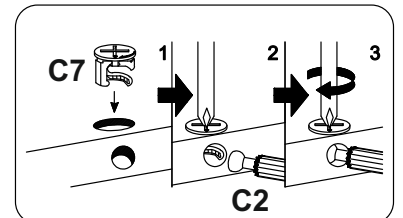
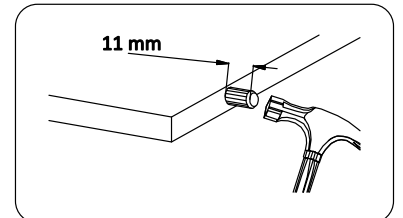
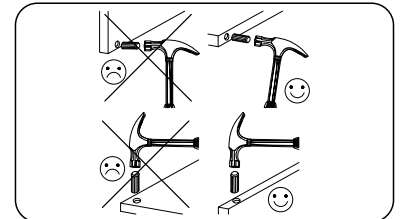
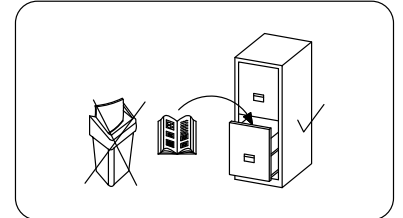
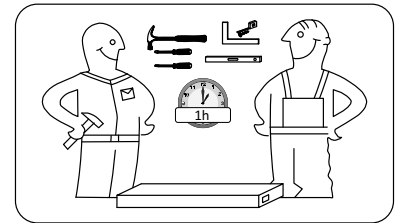

A

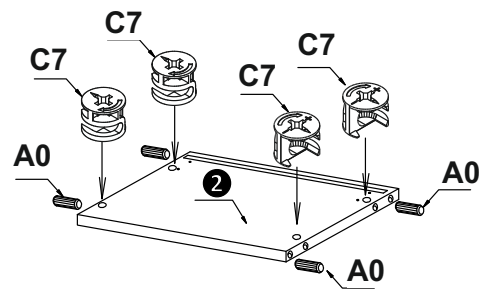
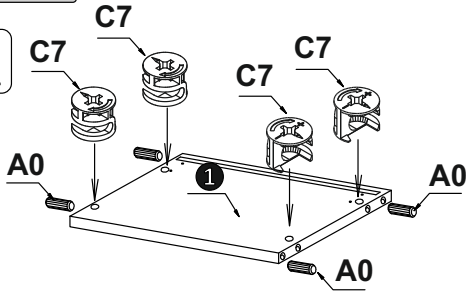

A

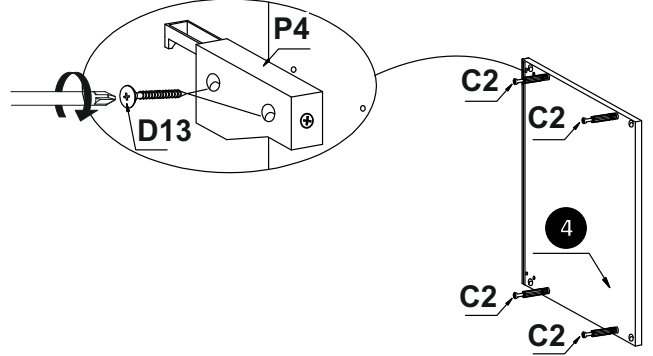
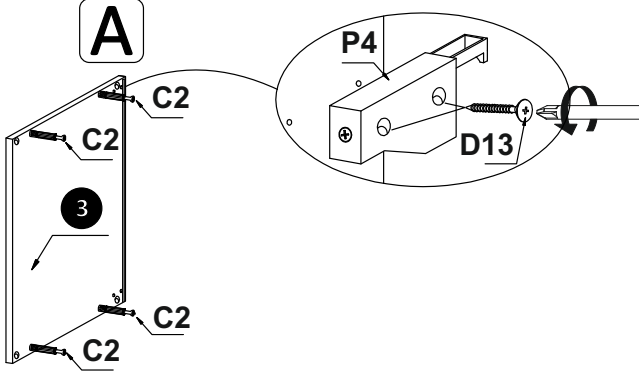

A

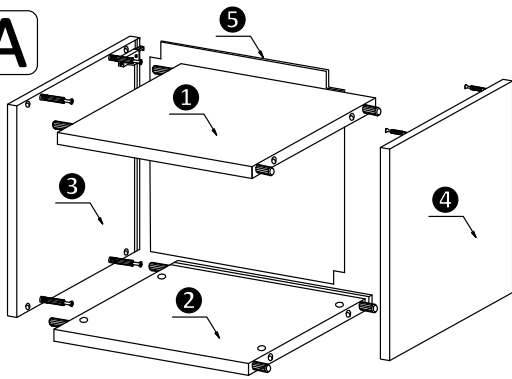

B

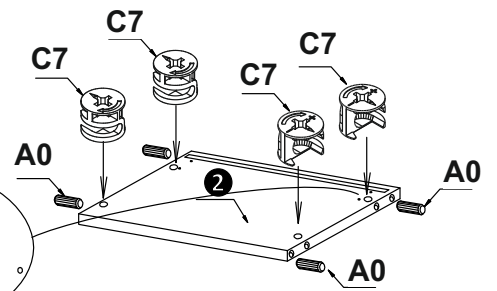
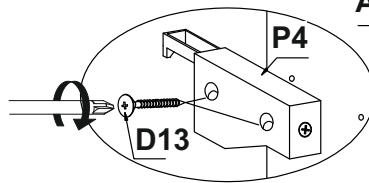
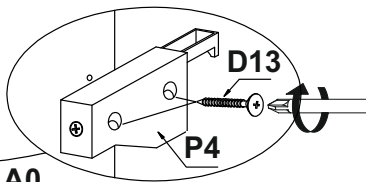
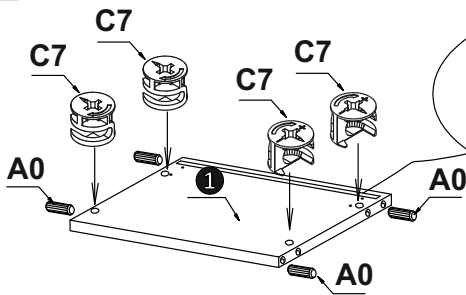

B

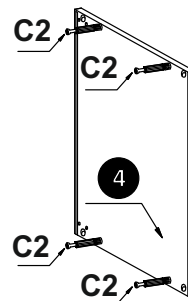
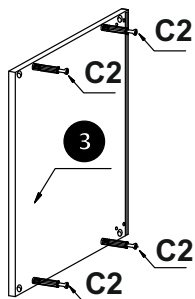

B

