

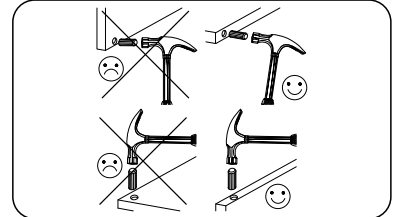

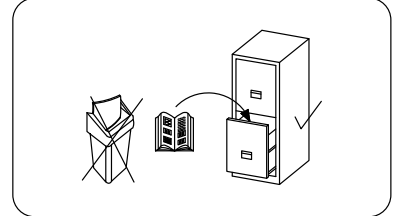

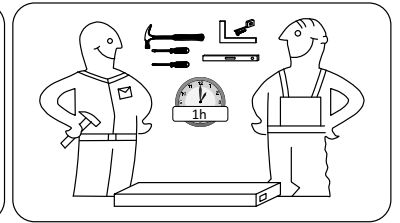

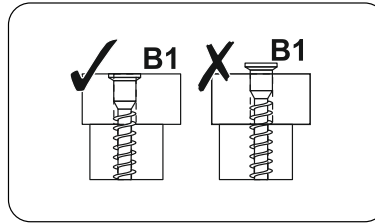

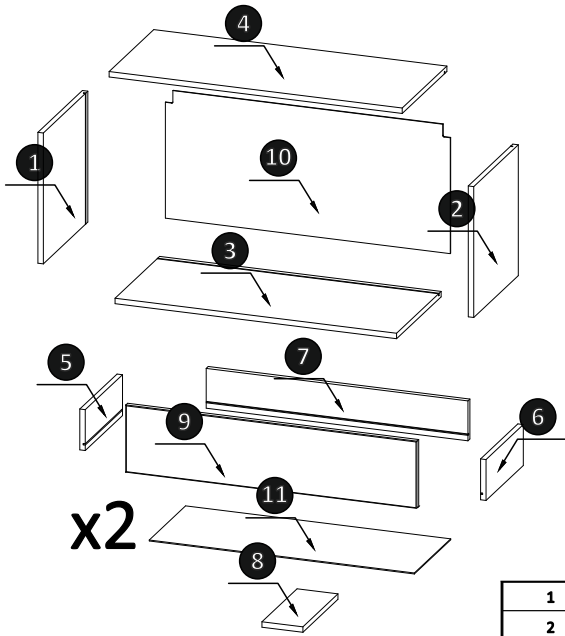
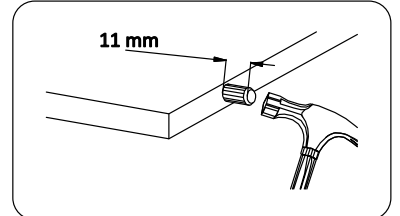

E9







1	1	368	359	16
2	1	368	359	16
3	1	860	360	16
4	1	860	360	16
5	2	300	120	16
6	2	300	120	16
7	2	768	117	16
8	2	283	120	16
9	2	854	197	16
10	1	836	377	3
11	2	778	293	3

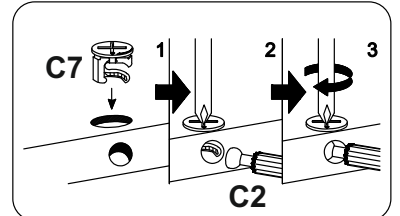

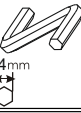
A0  8x30 24	B0  8	B1  7x50 10	C0  18	C2  18	C7  18	D0  3x15 22	D5  3,5x16 8	D13  4x30 4
--	---	--	--	--	--	--	---	---



D21  5x13 20	K  4mm 1	M1  22	N25  L-300 2	P4  2
---	---	--	---	---

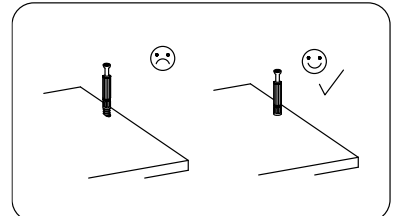
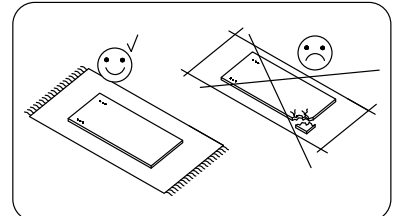
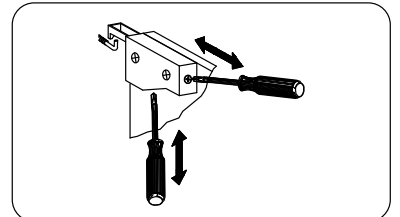

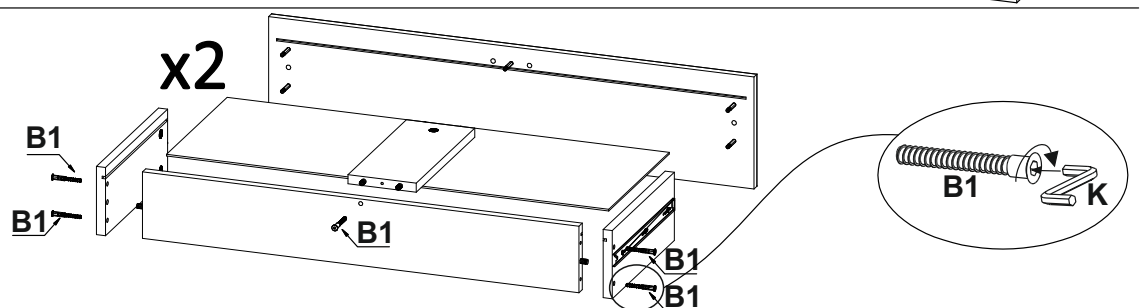
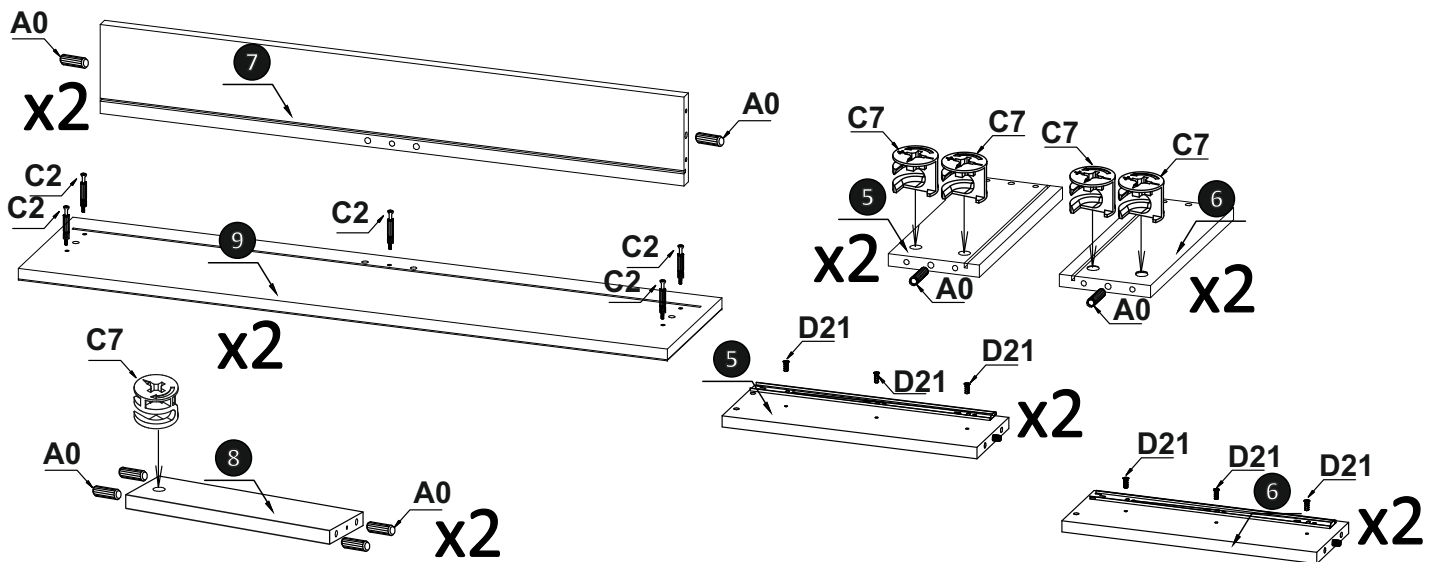
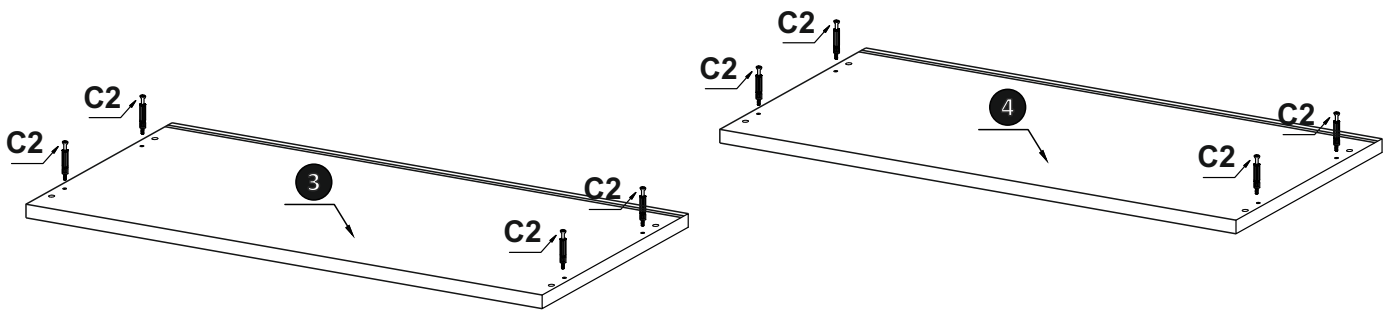
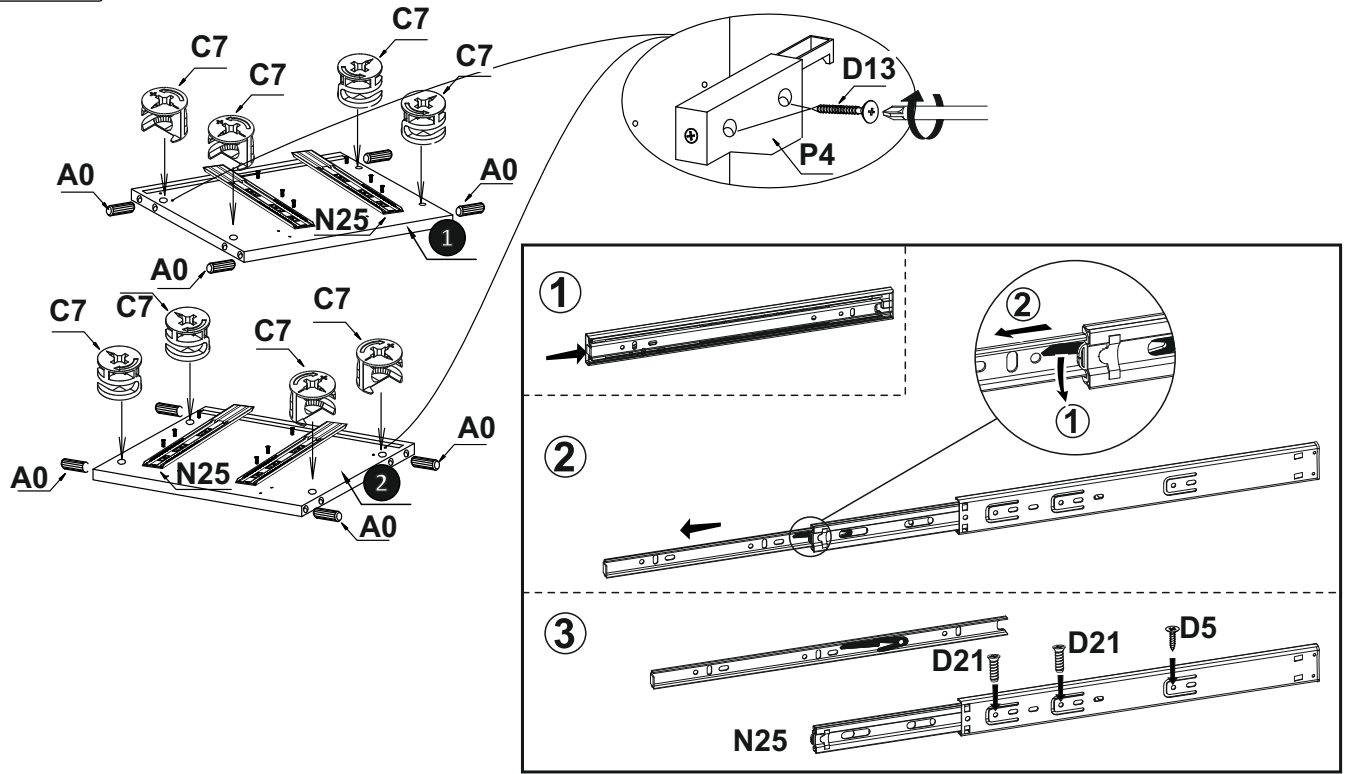

E9

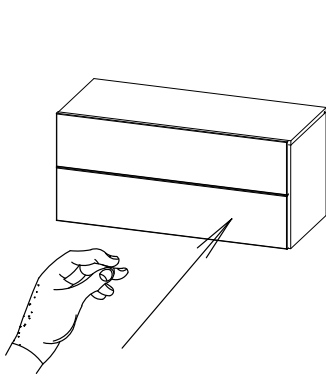
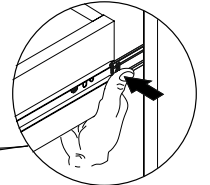
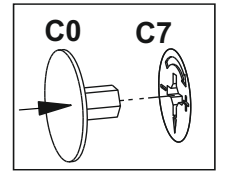
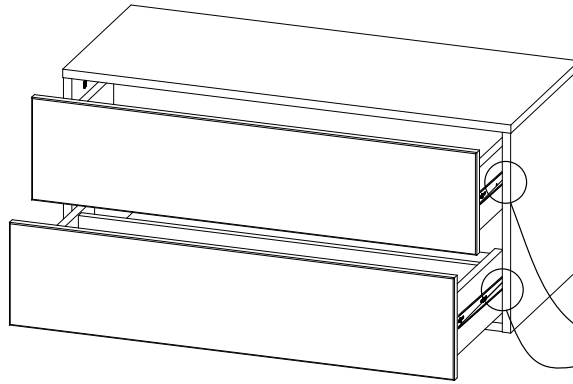
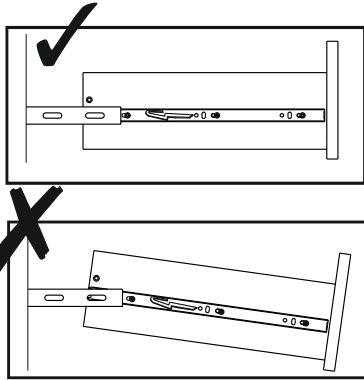
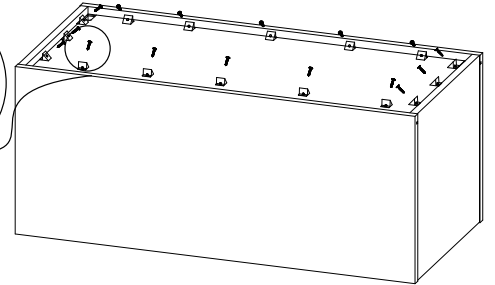
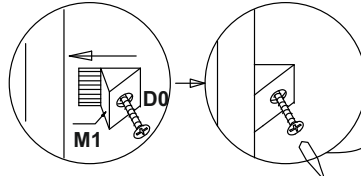
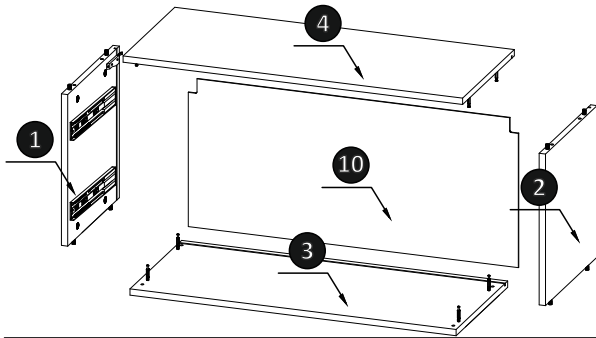
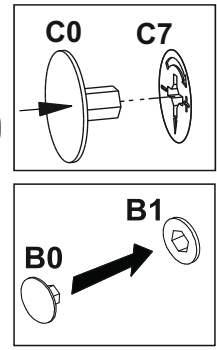
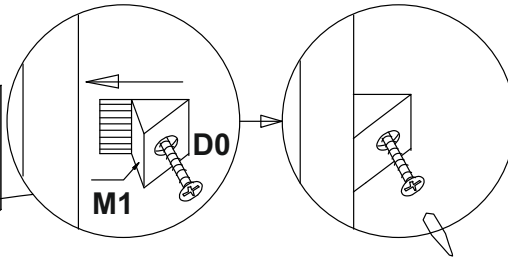
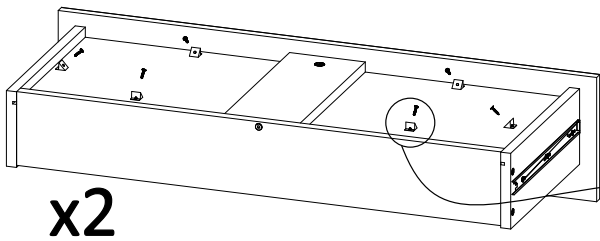

Push to open

