

1

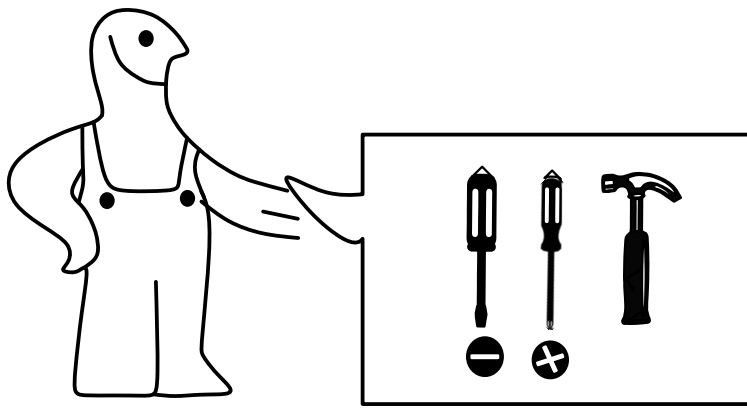

2

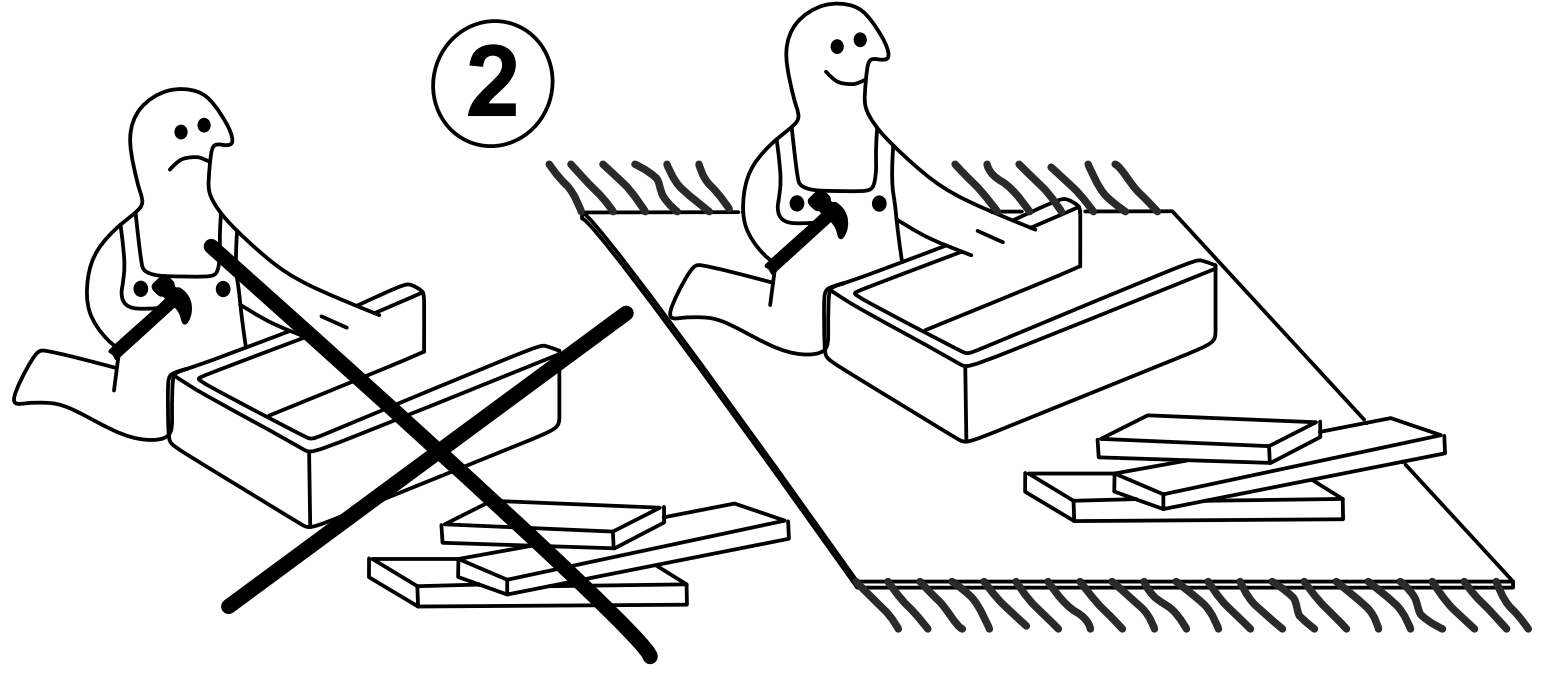

3

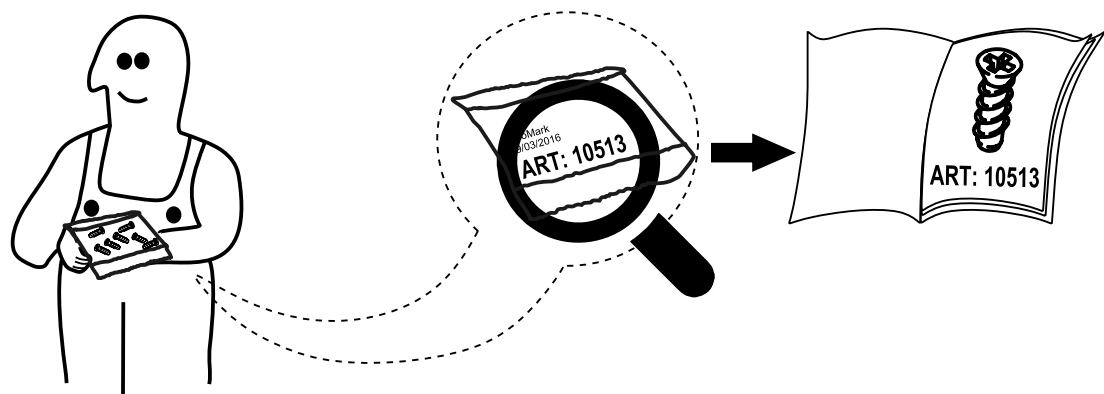

4

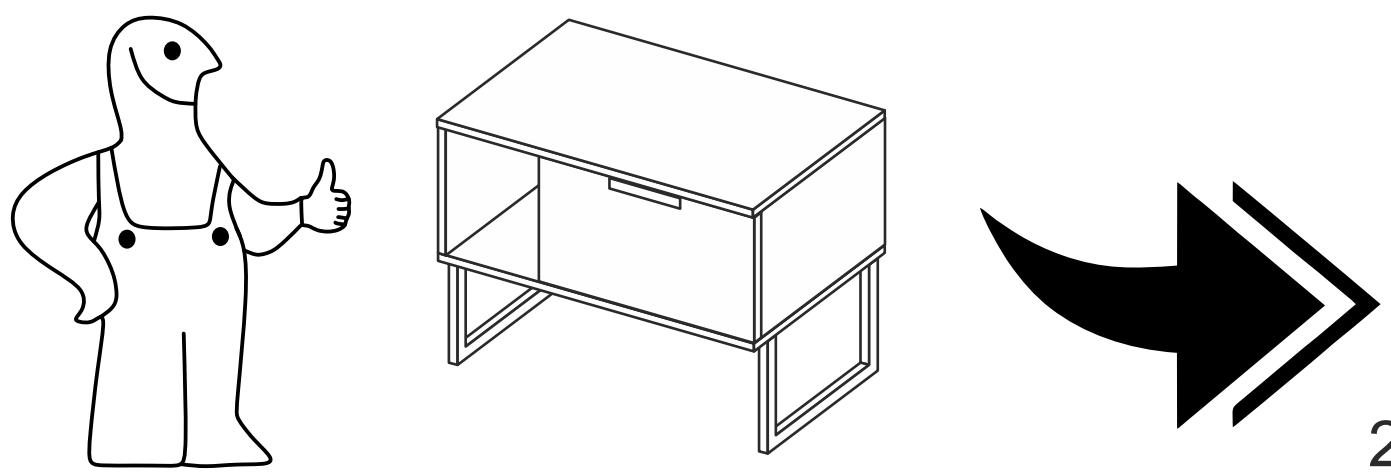

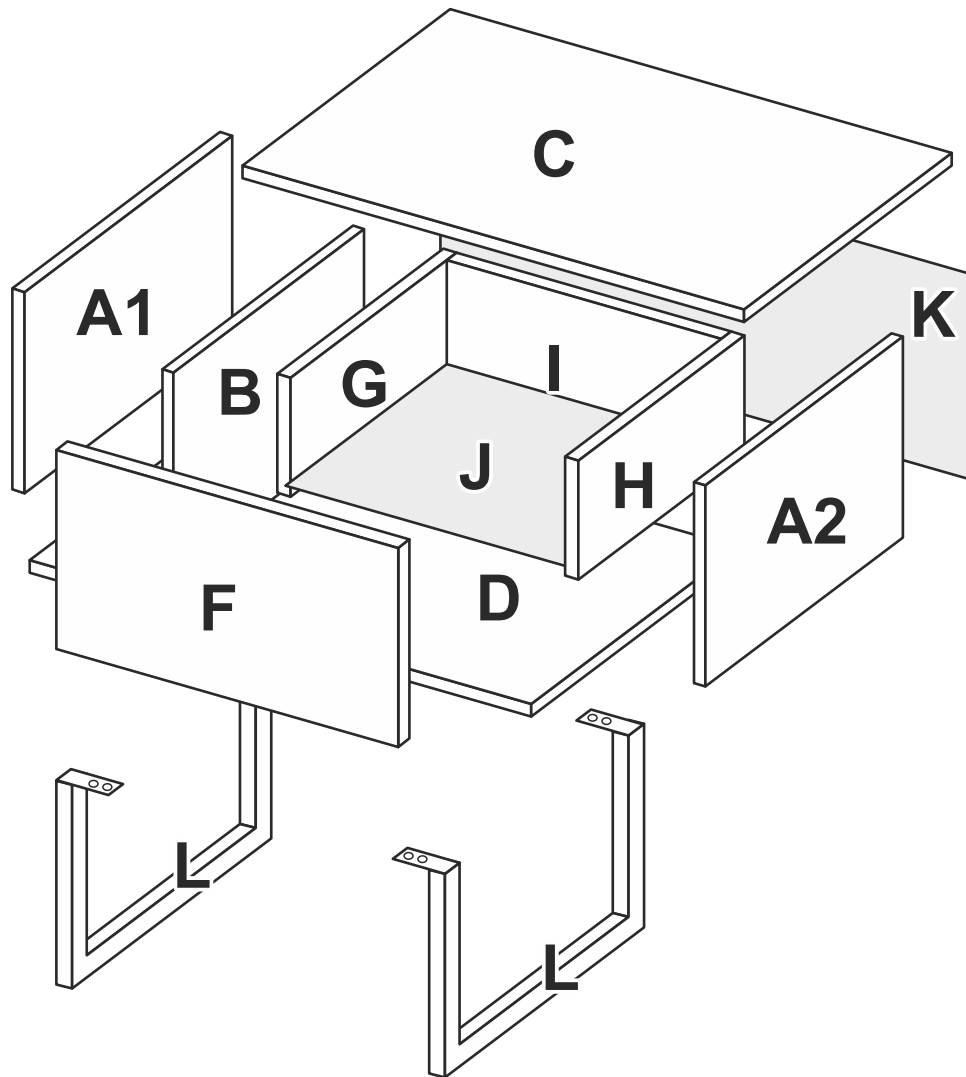

<b>A1</b>	-	218 x 376	x	16	-	x	1
<b>A2</b>	-	218 x 360	x	16	-	x	1
<b>B</b>	-	218 x 346	x	16	-	x	1
<b>C</b>	-	560 x 380	x	16	-	x	1
<b>D</b>	-	560 x 377	x	16	-	x	1
<b>F</b>	-	391 x 210	x	16	-	x	1
<b>G</b>	-	300 x 130	x	16	-	x	1
<b>H</b>	-	300 x 130	x	16	-	x	1
<b>I</b>	-	303 x 130	x	16	-	x	1
<b>J</b>	-	296 x 315	x	3	-	x	1
<b>K</b>	-	539 x 230	x	3	-	x	1
<b>L</b>	-	373 x 220	x	78	-	x	2

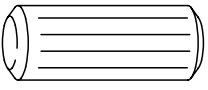
①  $\varnothing 8 \times 30$  x20  
  
**21008**

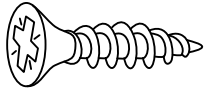
②  $\varnothing 4 \times 16$  x4  
  
**10416**

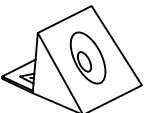
③ x4  
  
**08003**

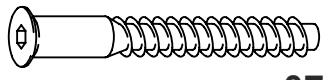
④  $\varnothing 6,4 \times 50$  x2  
  
**07650**

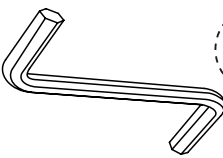
⑤ x1  
  
**07001**

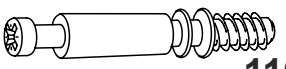
⑥ x14  
  
**11002**

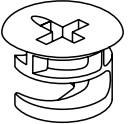
⑦ x14  
  
**11016**

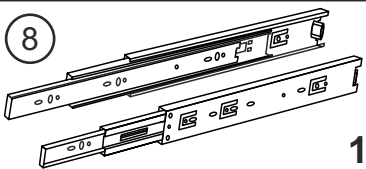
⑧ x1  
  
**12300**

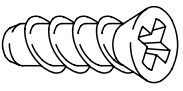
⑨  $\varnothing 5 \times 13$  x8  
  
**10513**

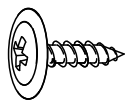
⑩  $\varnothing 4.2 \times 13$  x2  
  
**10413**

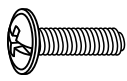
⑪  $\varnothing 6 \times 16$  x8  
  
**10616**

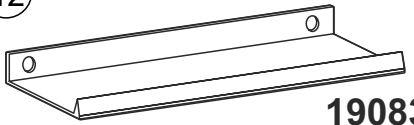
⑫ x1  
  
**19083**



