

L=20mm D2 8	±15/12mm C 8	±8x30mm A 12	H=0 H 2	±35/0mm G 2	±3.5x13mm P5 7	 E 4	 T3 4	 P1 8	 P11 3
-----------------------	------------------------	------------------------	-------------------	-----------------------	--------------------------	------------	-------------	-------------	--------------

 L23 1	 K13 1
--------------	--------------

1

L=20mm D2 8	±15/12mm C 8	±8x30mm A 12	T3 4	±4.0x16mm P1 4	L23 1
-------------------	--------------------	--------------------	---------	----------------------	----------

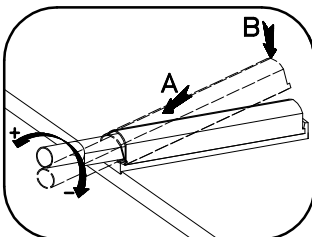
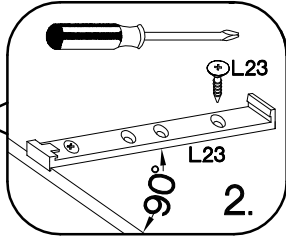
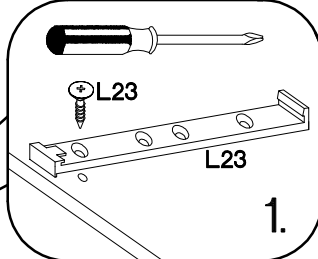
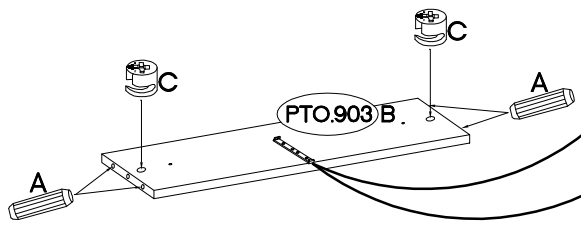
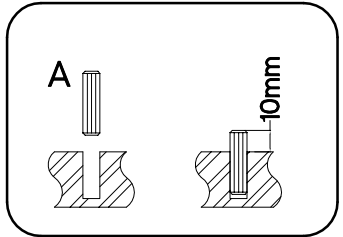
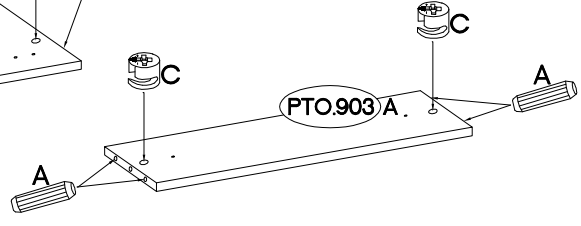
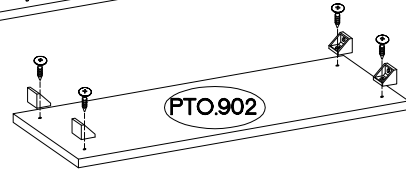
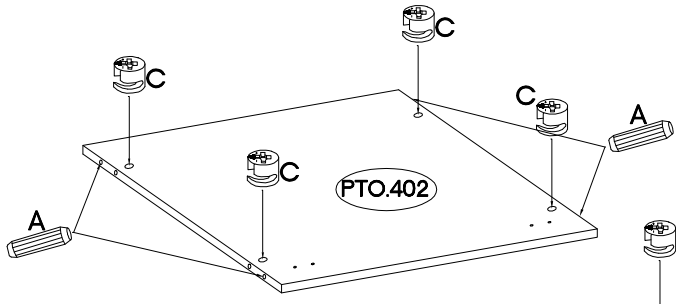
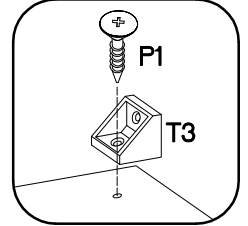
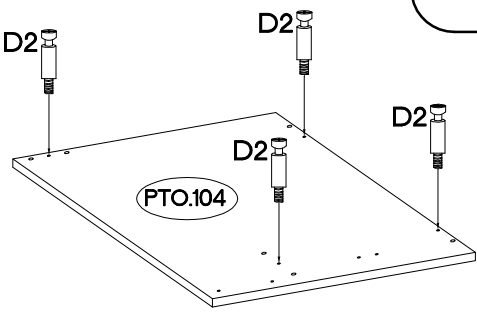
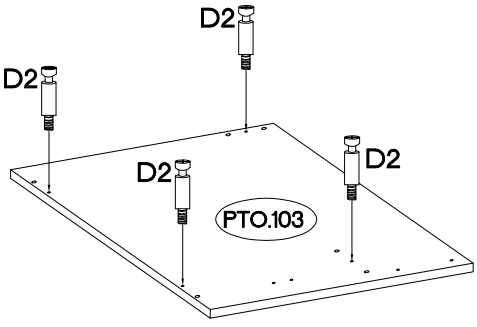
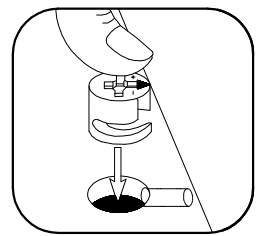
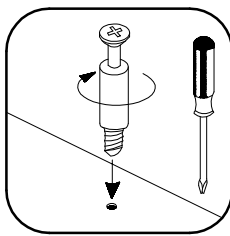

2

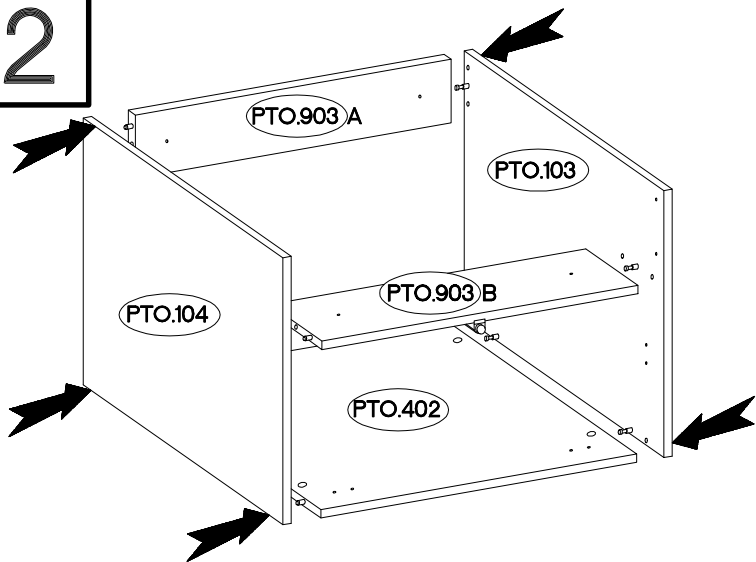

3

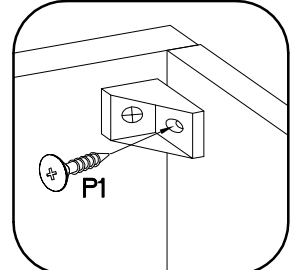
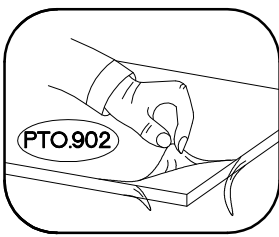
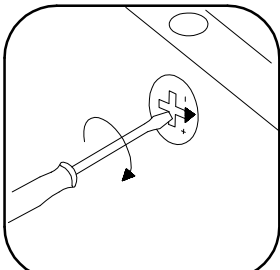
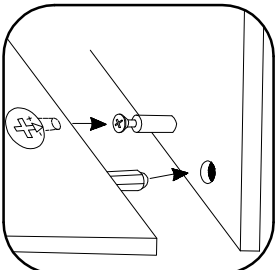
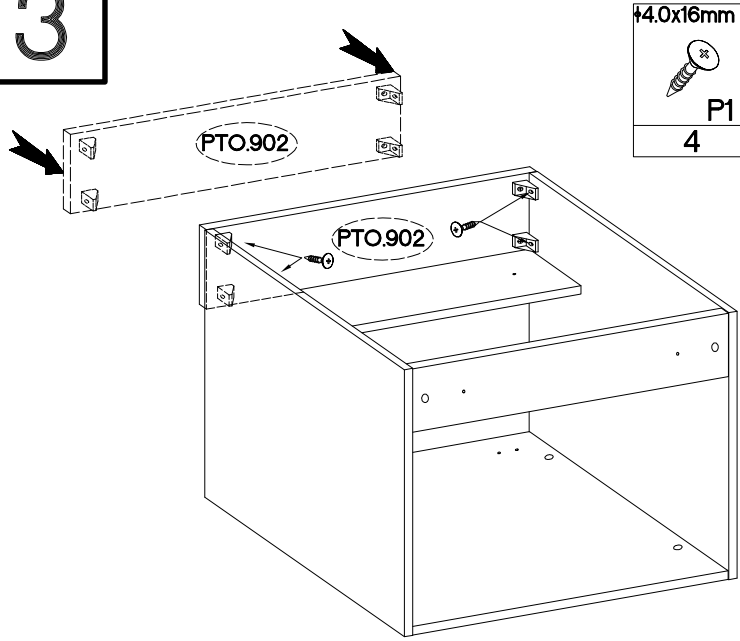

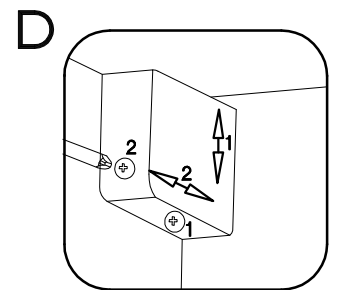
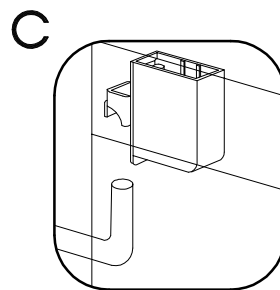
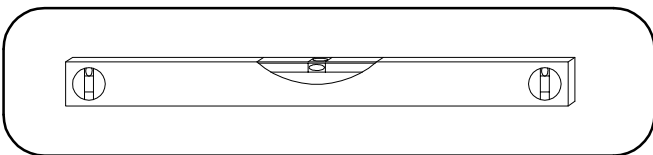
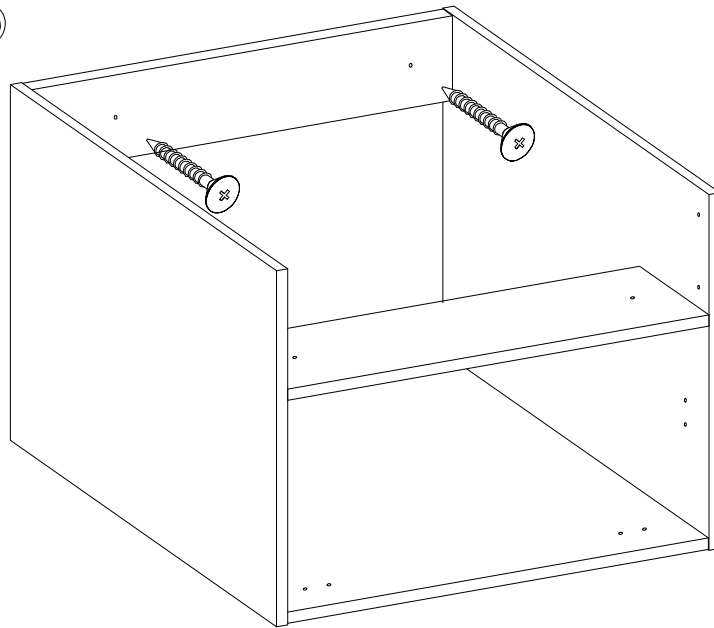
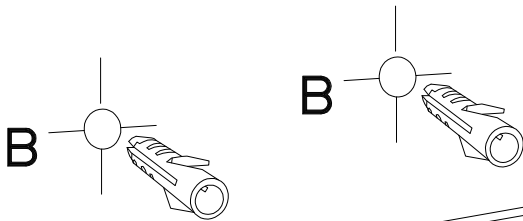
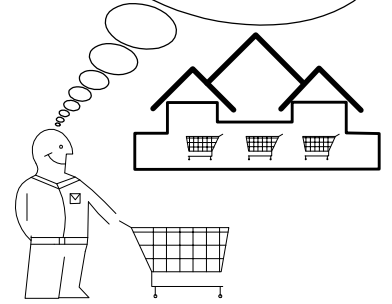
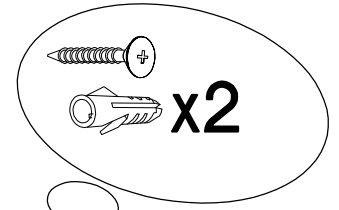
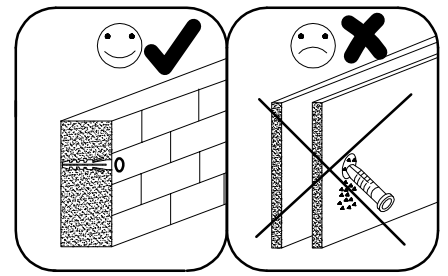
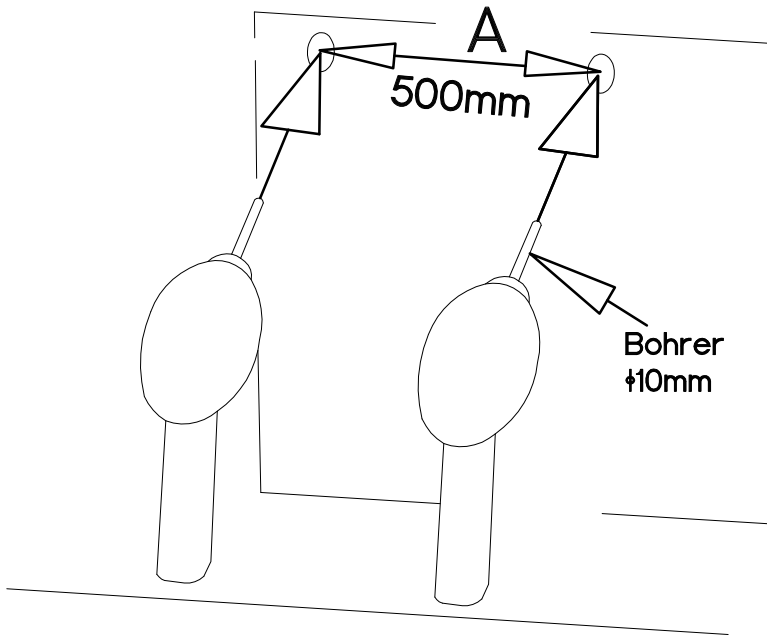

5

±35/0mm
G
2
±3.5x13mm
H-0
P5
2
4

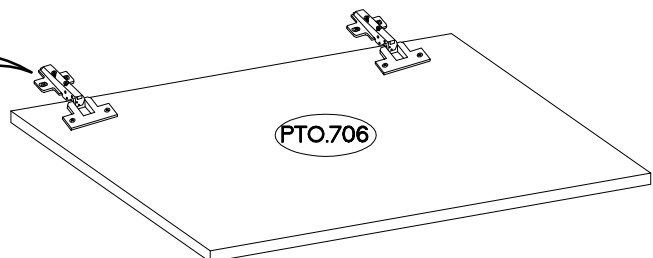
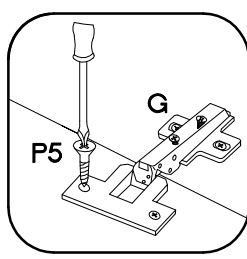
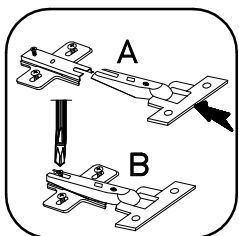

6

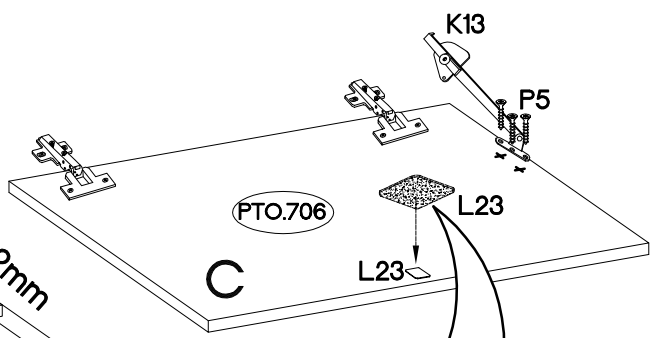
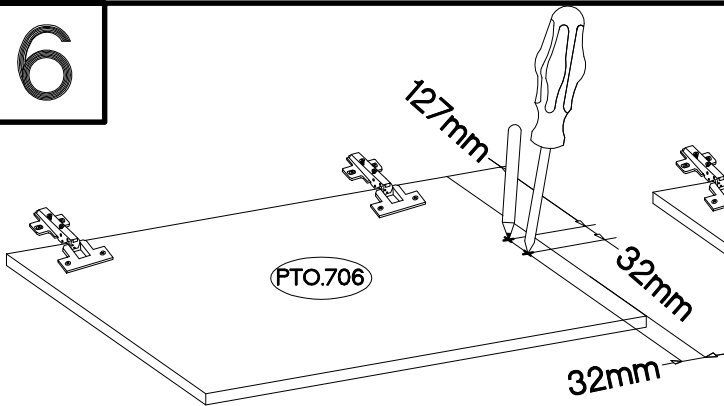

±3.5x13mm
K13
1
P5
3
L23
1

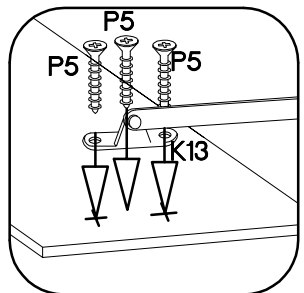
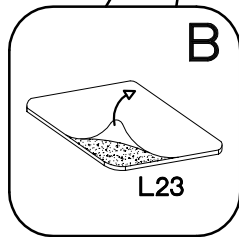
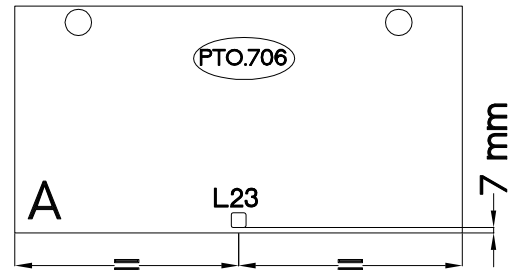
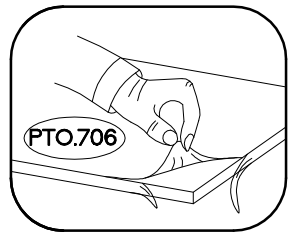

7

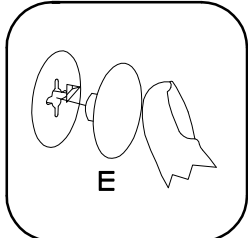
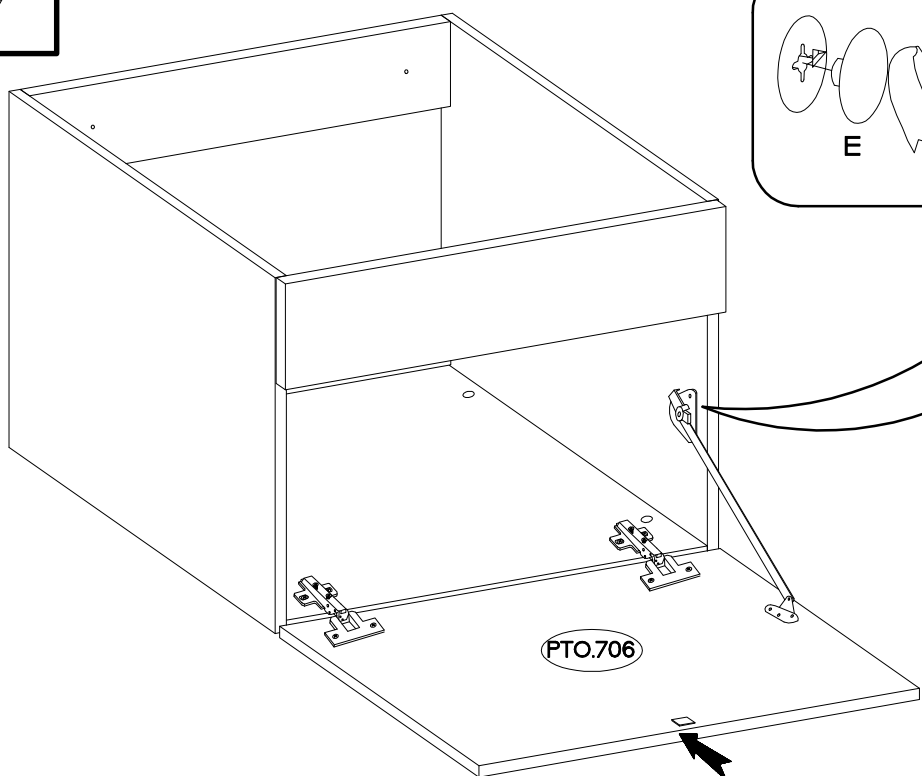

±3.0x16mm
P11
3
E
4

