

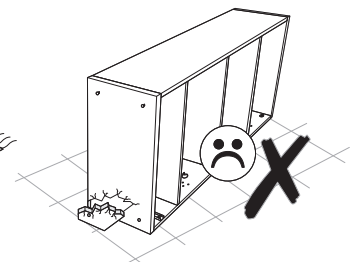

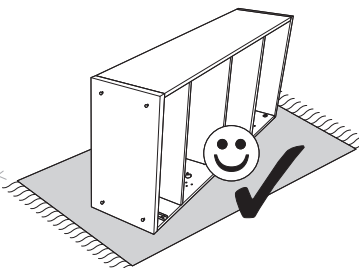

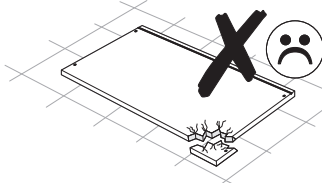

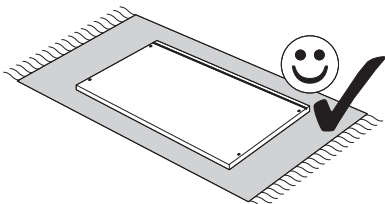

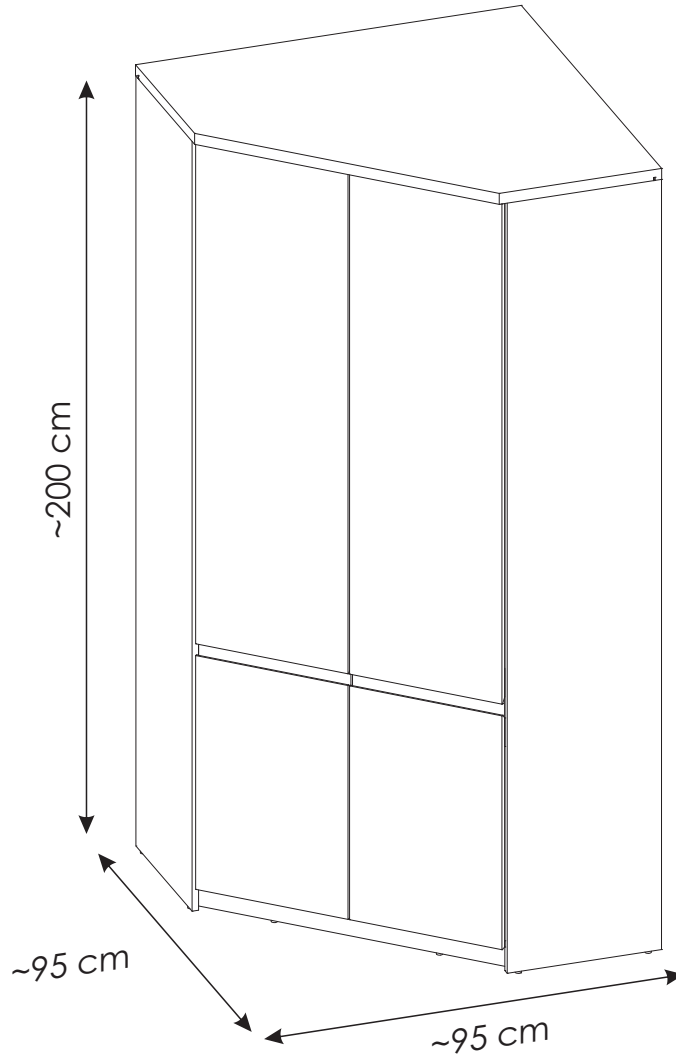
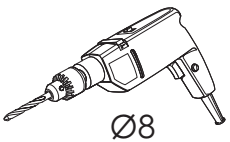
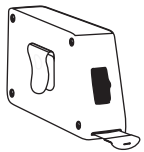
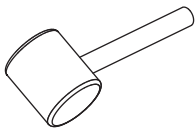
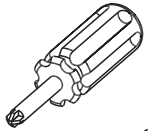
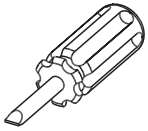
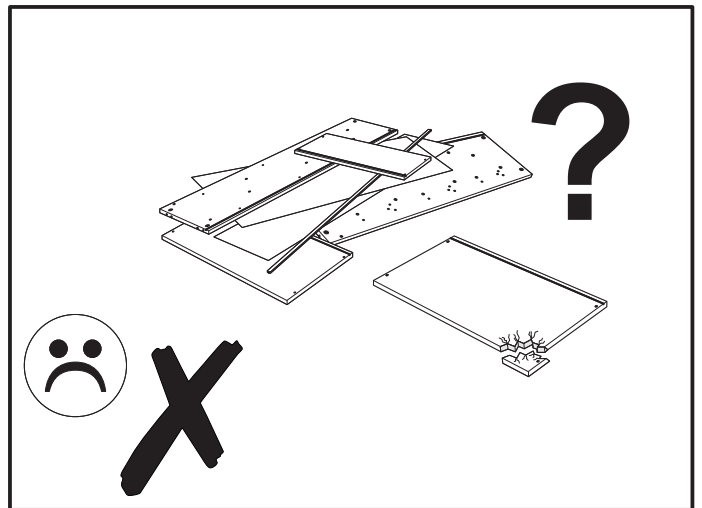
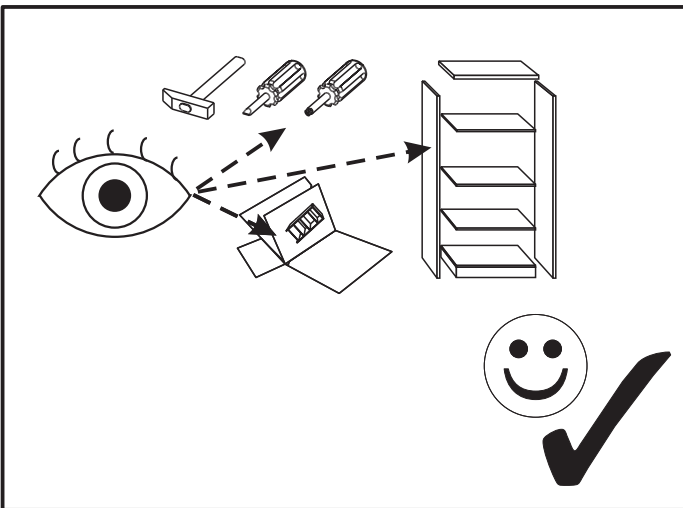
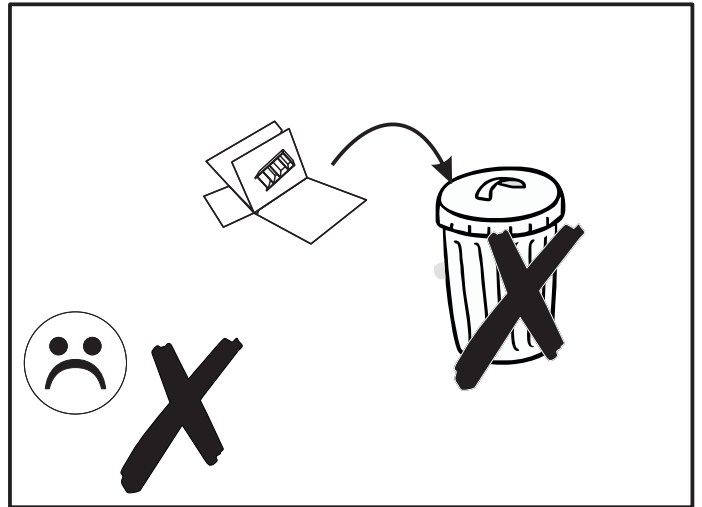
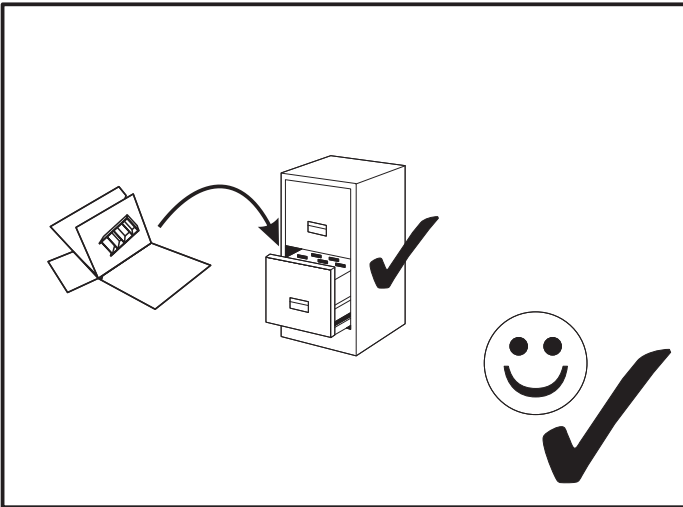
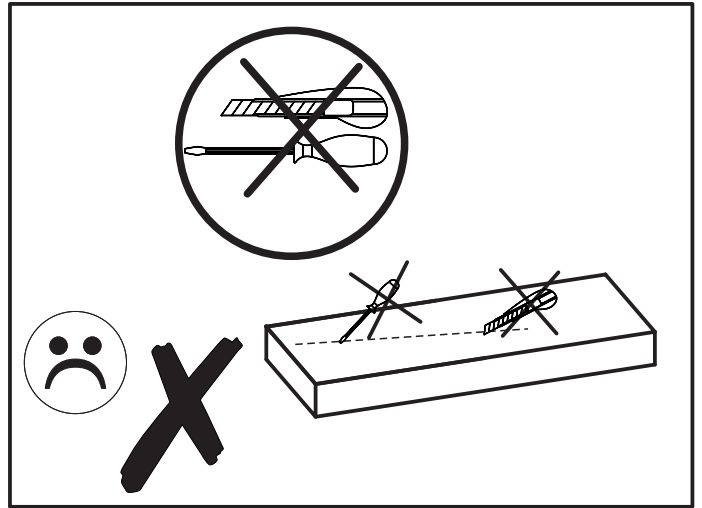
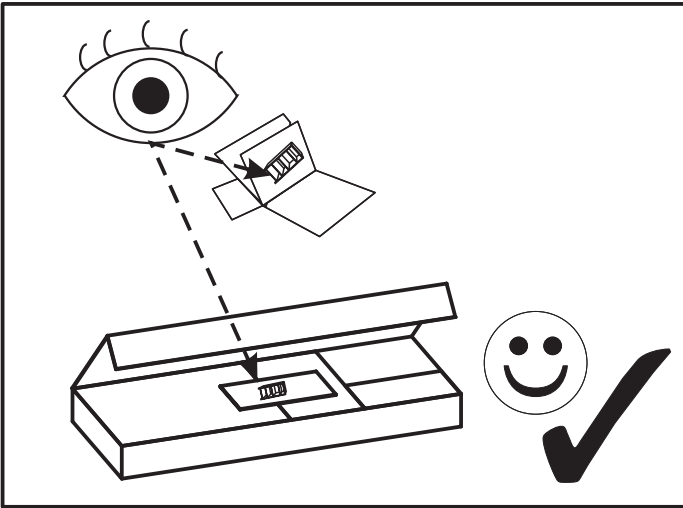
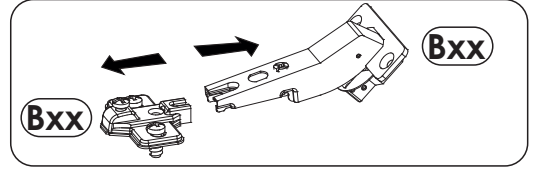
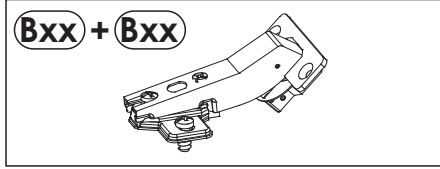
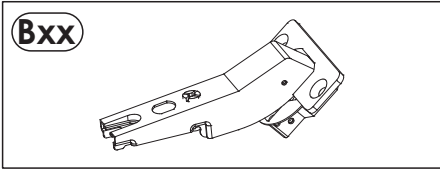
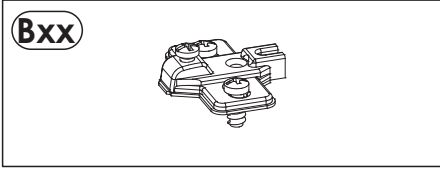



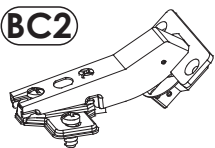

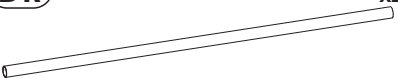
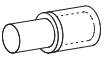

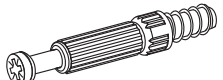
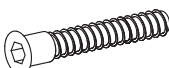
120 min

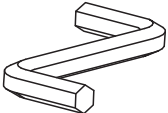

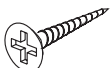
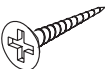
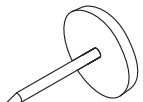

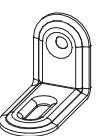
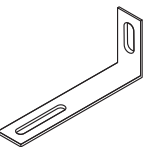
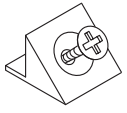
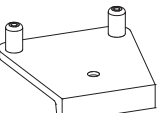
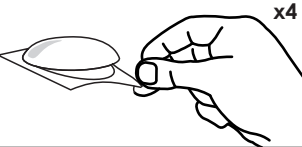
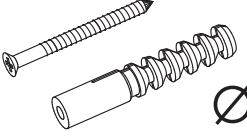

A0 8 x 24 mm x12 	A1 8 x 35 mm x34 	BA1 + BC2 x8 
C2 4 x 13 mm x16 	DR L - 905 mm x2 	D2 x16 
E0 Ø16 x12 	E1 15 x 12 mm x28 	F1 6 x 34 mm x28 
G1 7 x 50 mm x7 	I2 4 x 16 mm x2 	J2 4 x 25mm x12 
M x1 	NO 3 X 13 mm x1 	N1 3 X 16 mm x25 
N2 3,5 X 16 mm x18 	O2 x13 	P16 x12 
Q8 x3 	Q9 x2 	R4 x18 
R5 x1 	R8 x4 	S13 x2  Ø8
Z1 x4 		

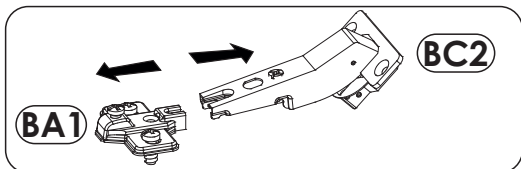
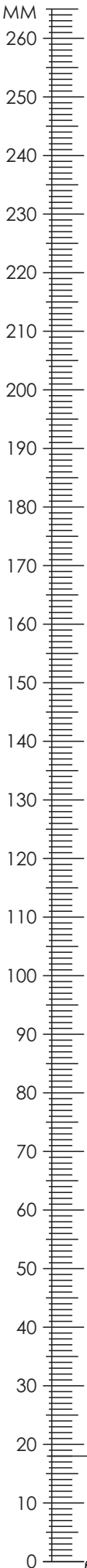

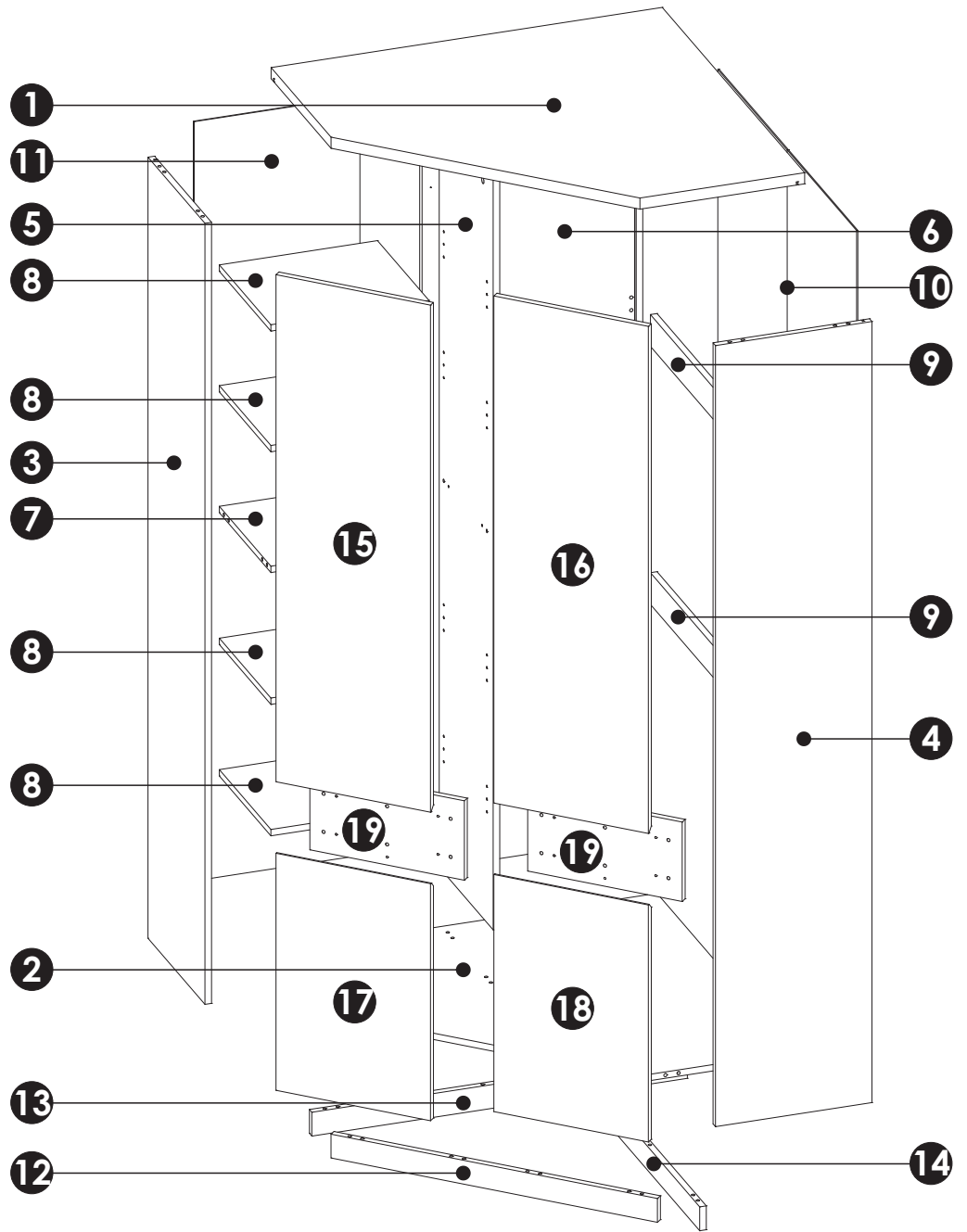
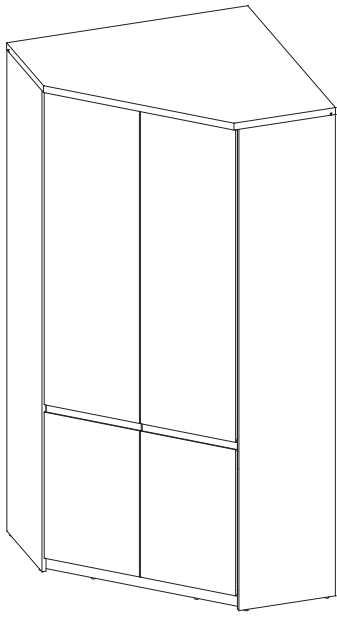

1	950	950	28	x1	2/3
2	913	913	16	x1	2/3
3	1967	380	16	x1	3/3
4	1967	380	16	x1	1/3
5	1891	360	16	x1	3/3
6	1967	536	16	x1	3/3
7	384	344	16	x1	1/3

8	384	344	16	x4	1/3
9	913	80	16	x2	2/3
10	1912	926	3	x1	3/3
11	1912	403	3	x1	3/3
12	822	60	16	x1	2/3
13	912	60	16	x1	2/3
14	708	60	16	x1	2/3

15	1277	389	16	x1	1/3
16	1277	389	16	x1	1/3
17	597	389	16	x1	1/3
18	597	389	16	x1	1/3
19	200	389	16	x2	2/3

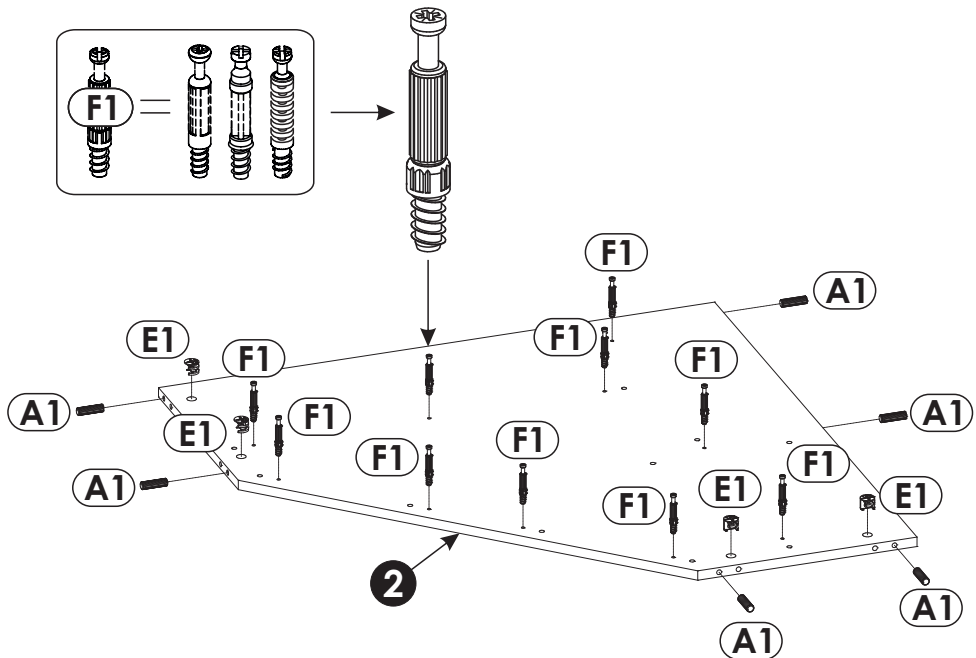
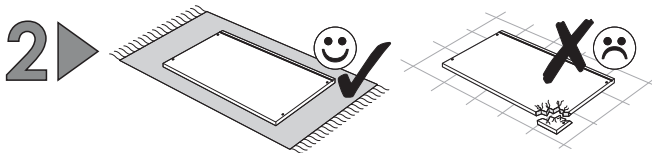
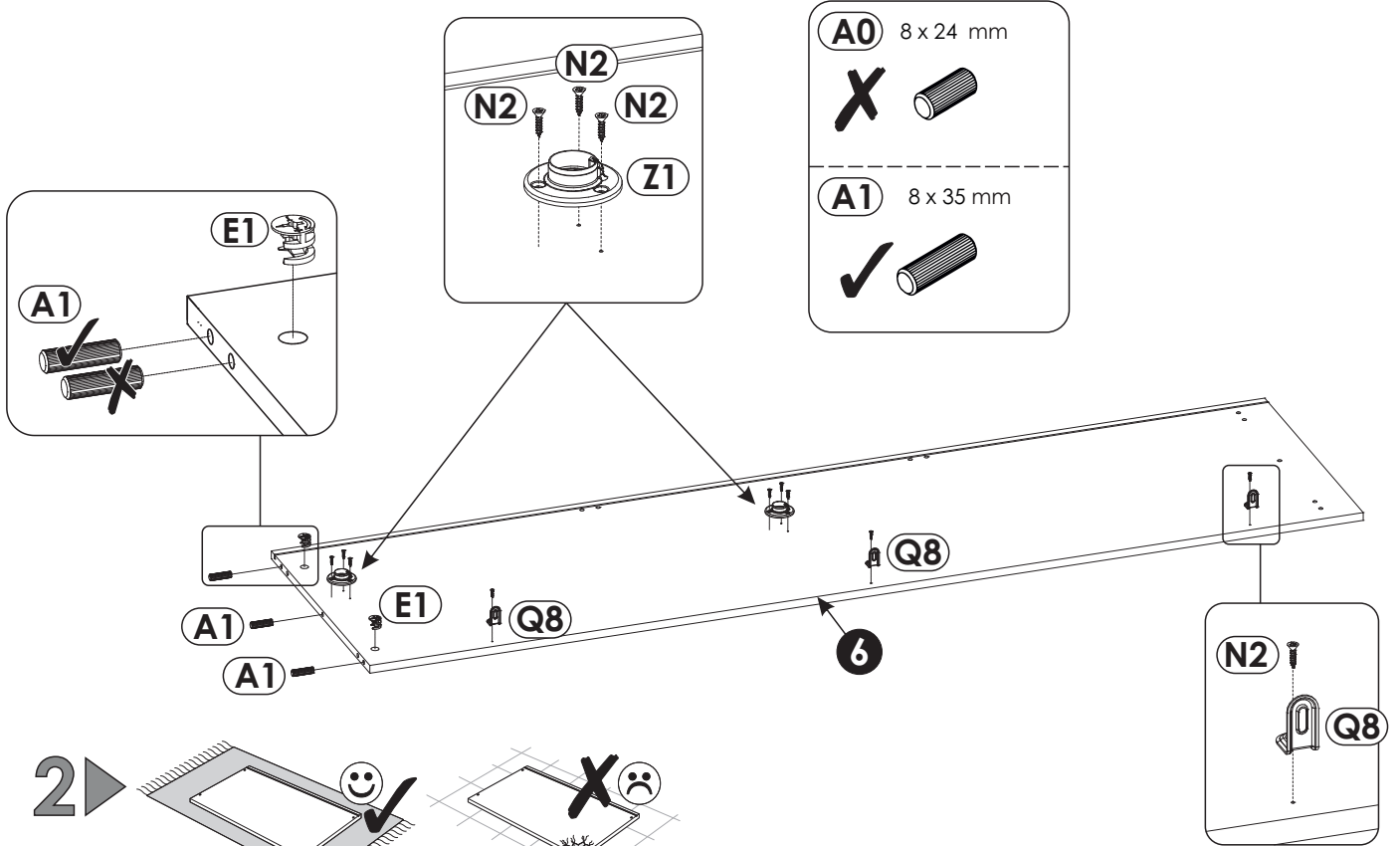
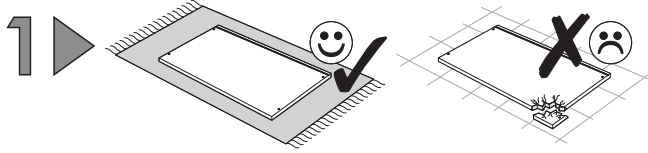
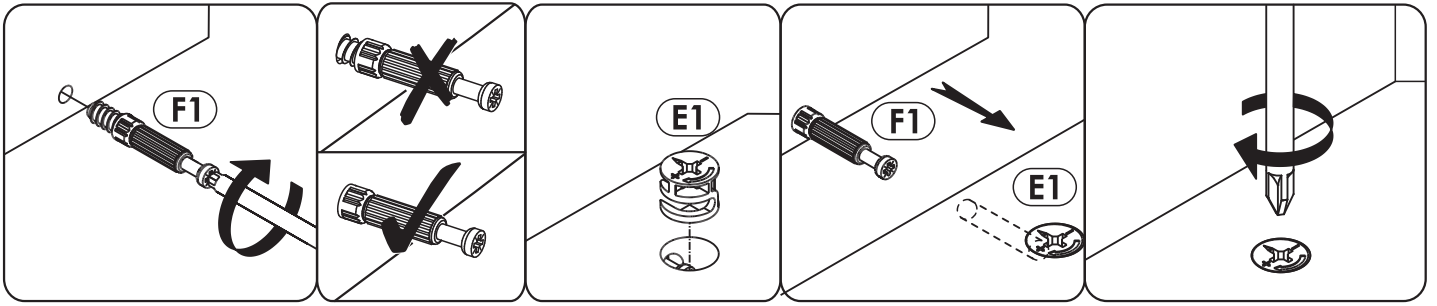

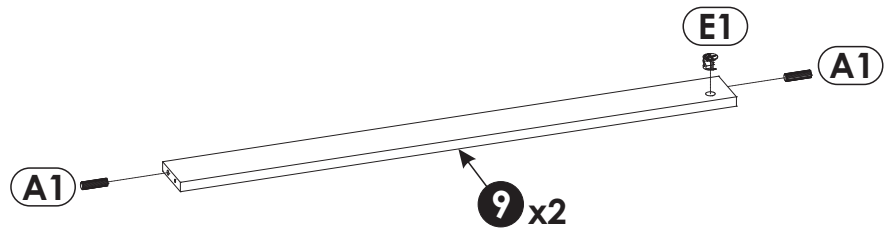
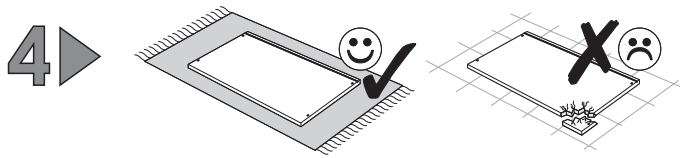
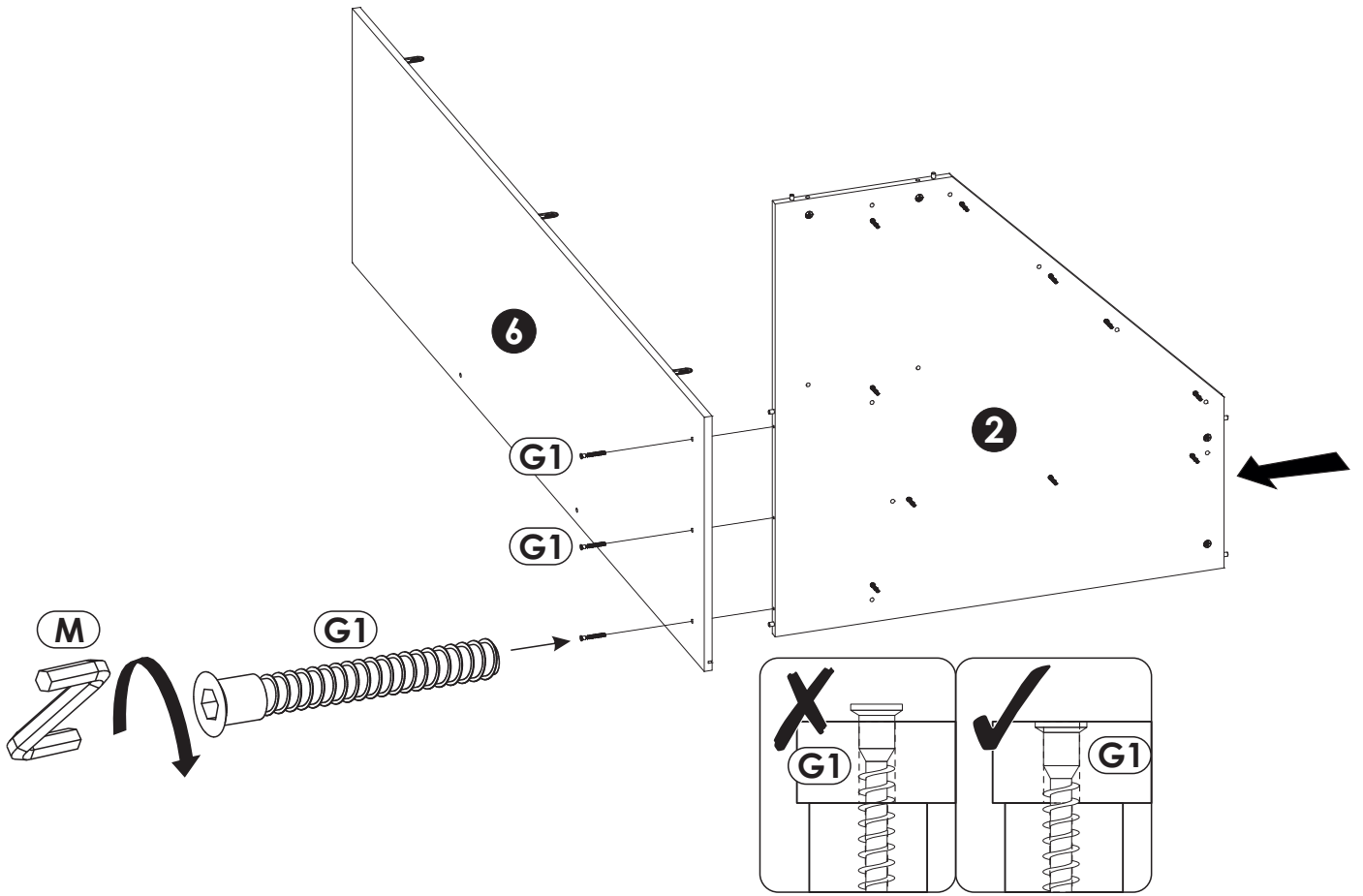
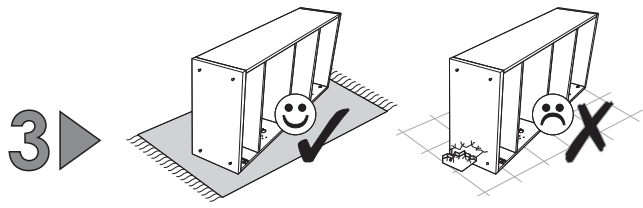

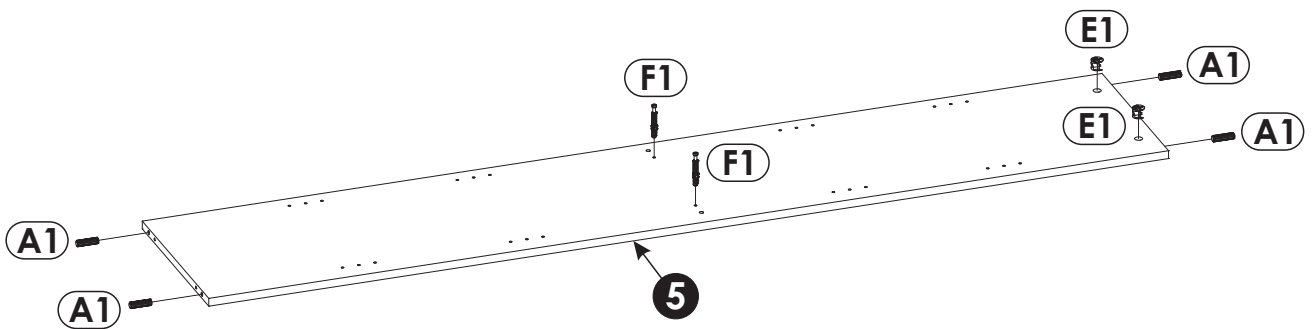
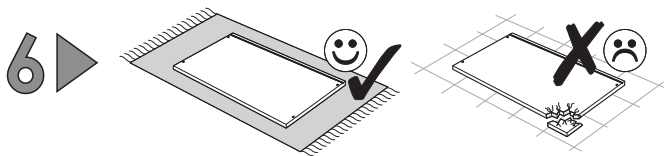
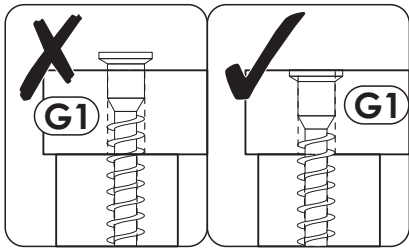
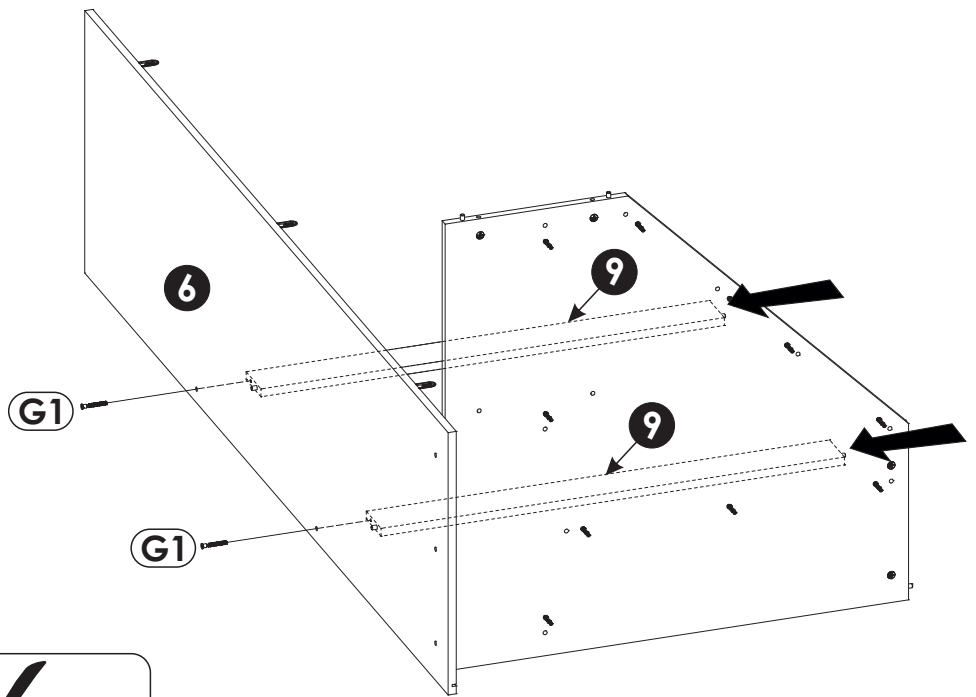
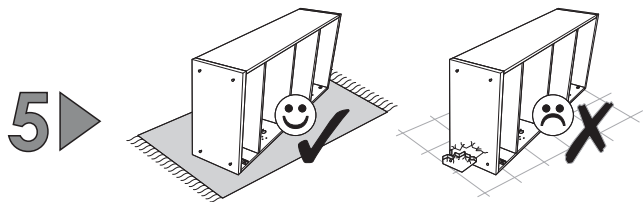

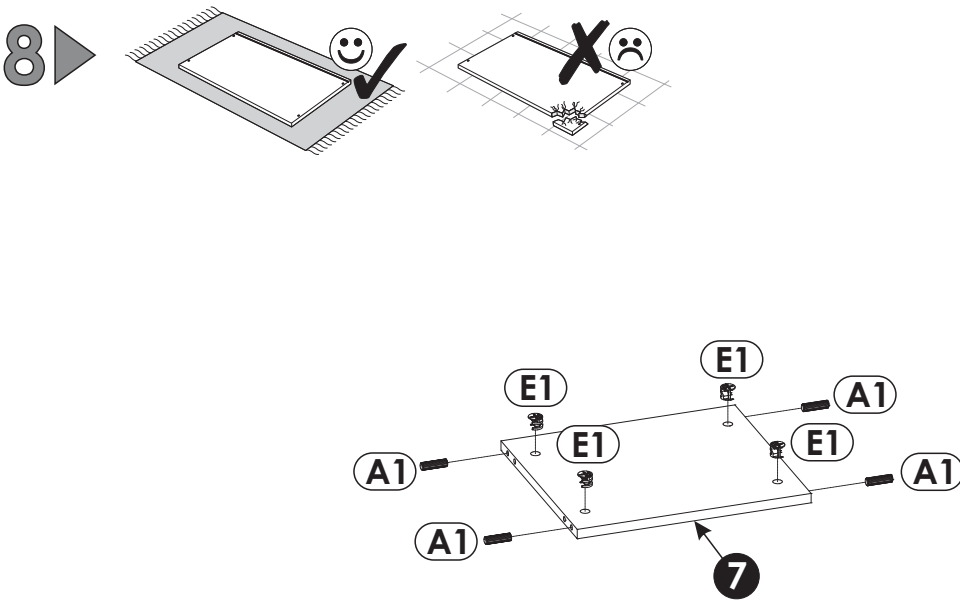
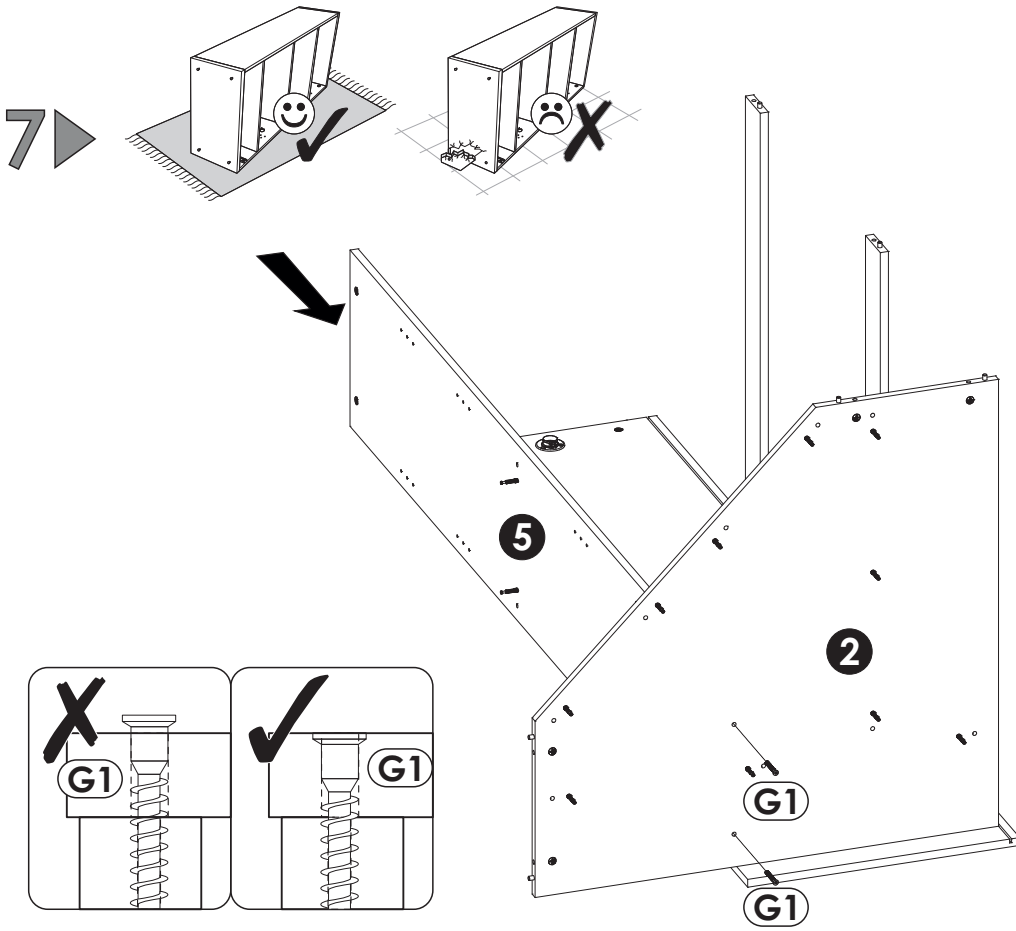

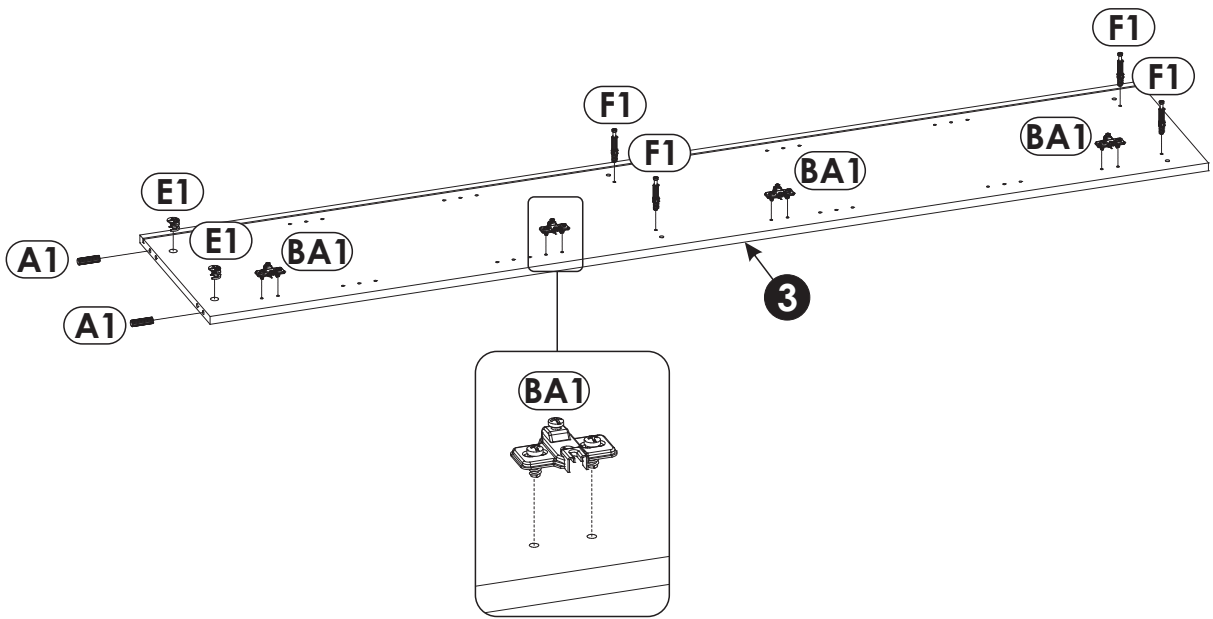
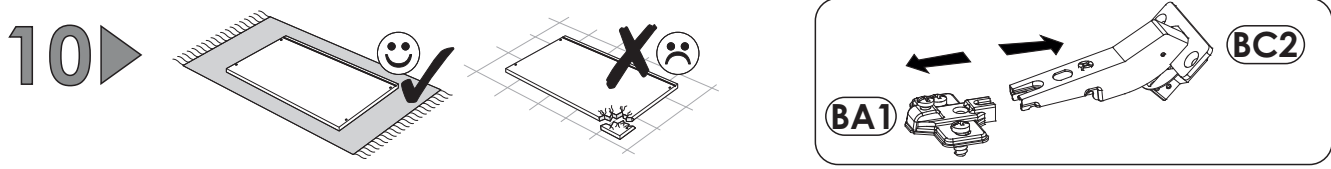
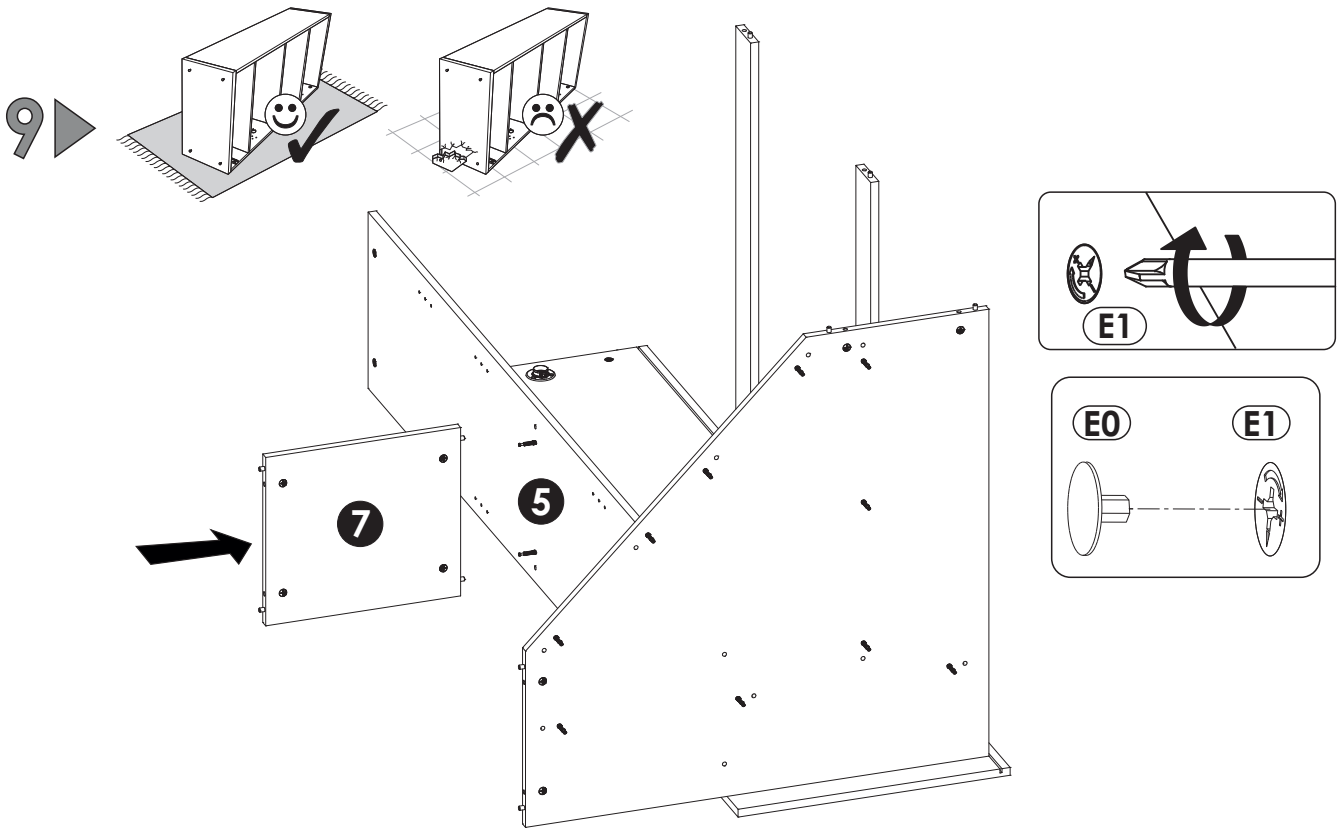

11 ▶

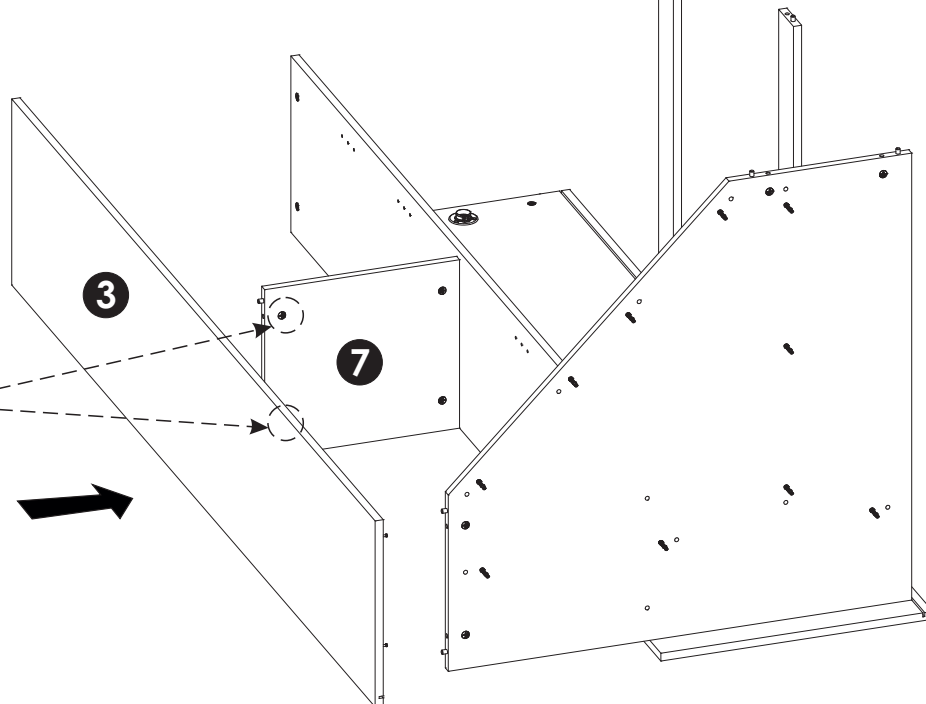
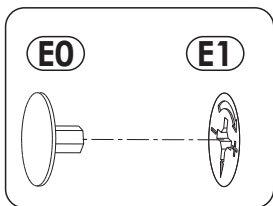
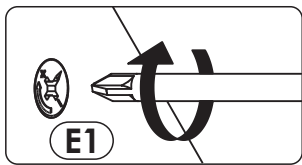
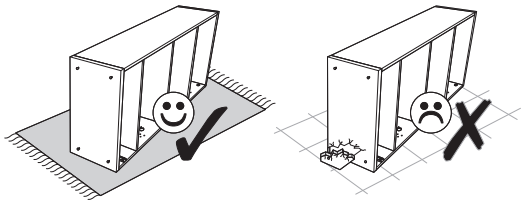

12 ▶

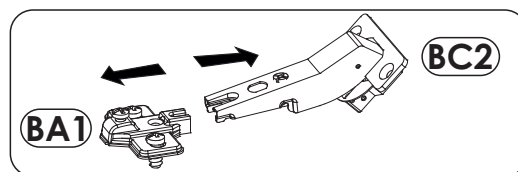
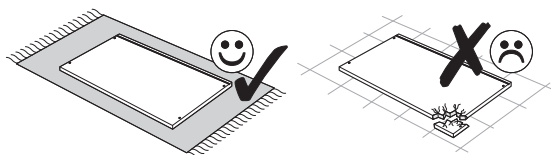

A0 8 x 24 mm x12



A1 8 x 35 mm x34

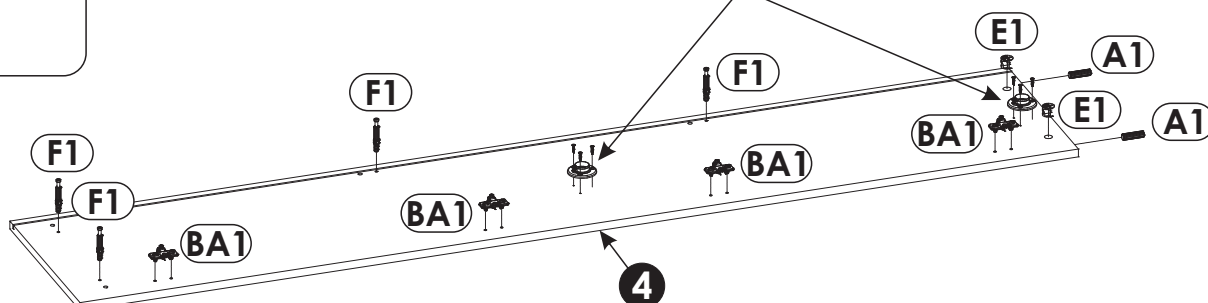
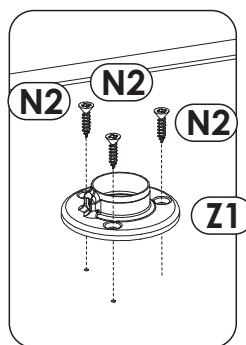
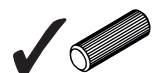

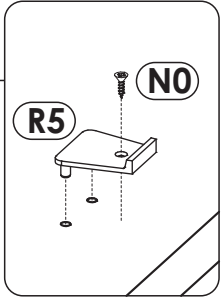
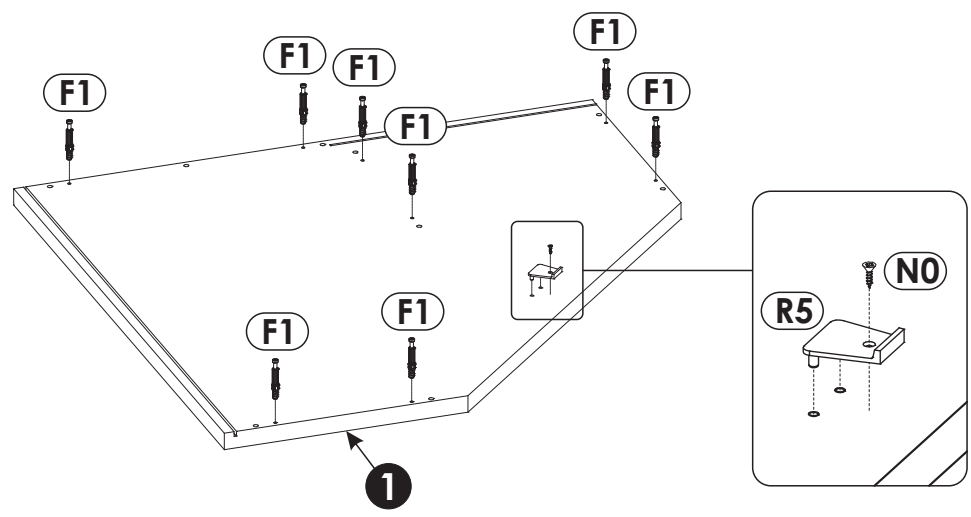
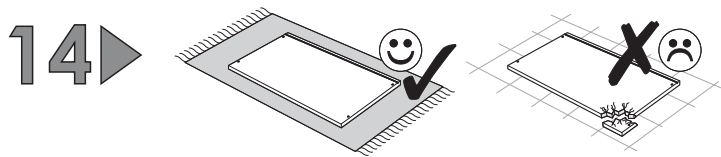
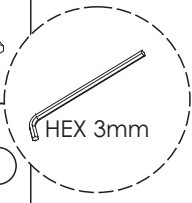
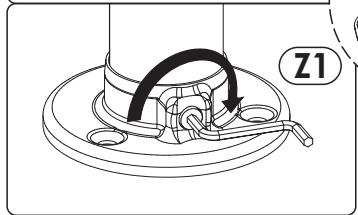
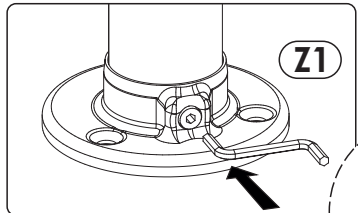
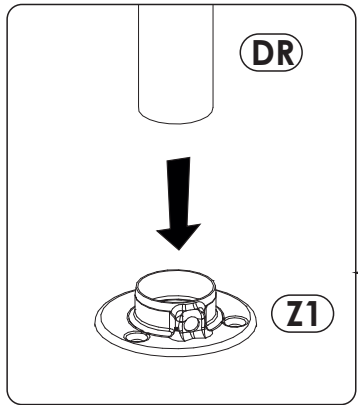
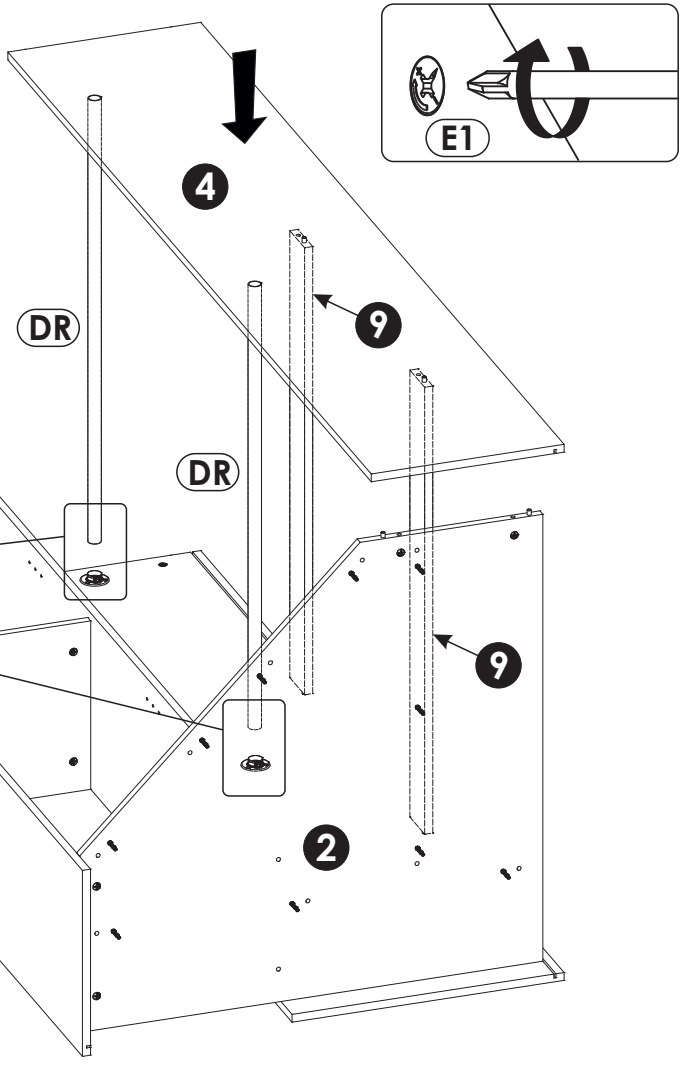
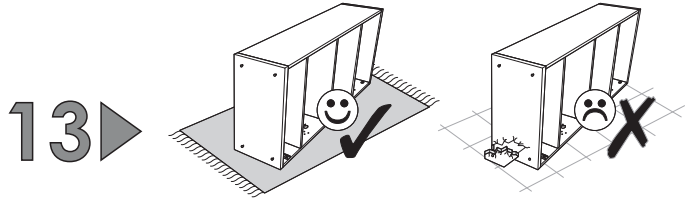

15 ▶

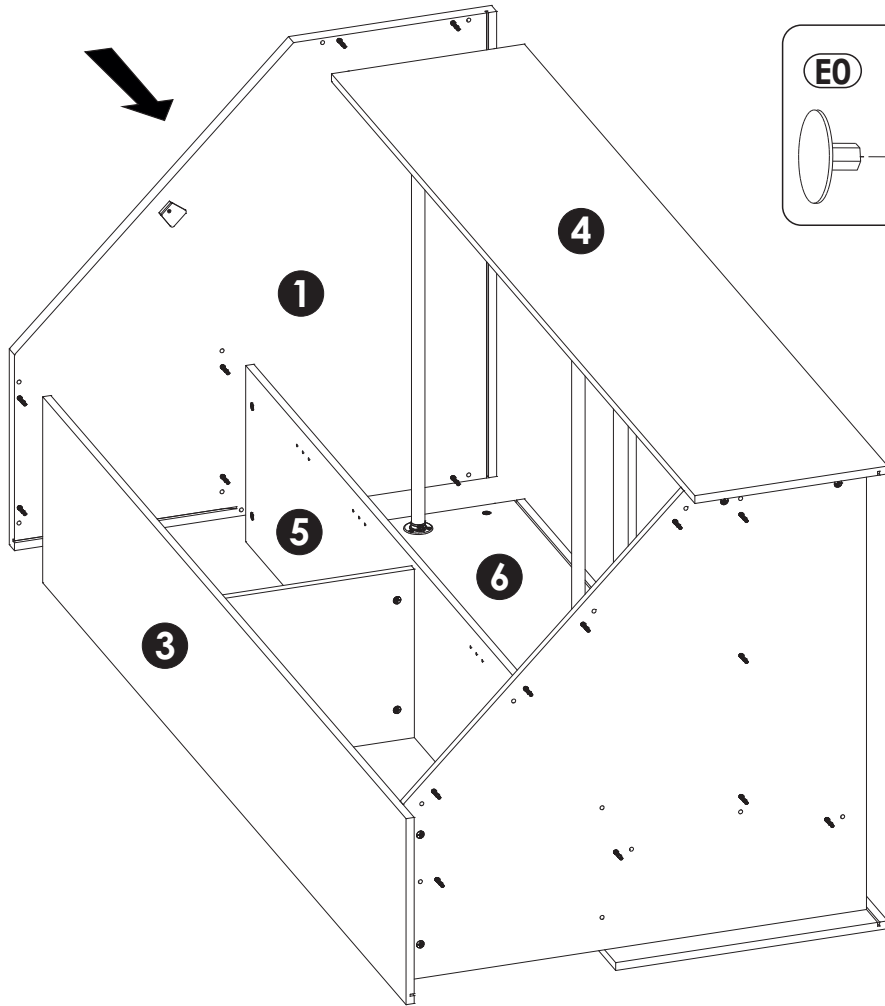
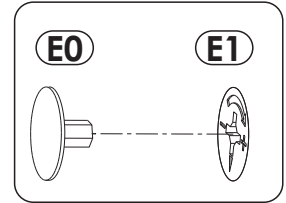
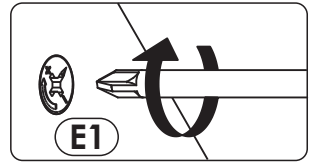
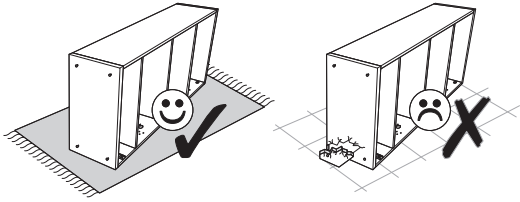

16 ▶

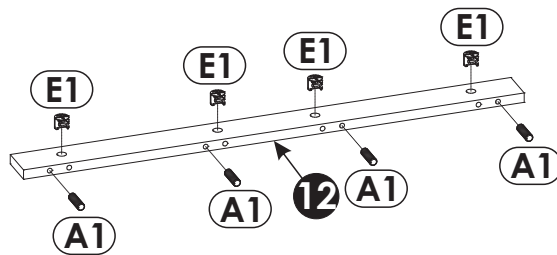
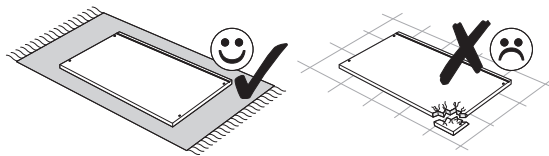

17▶

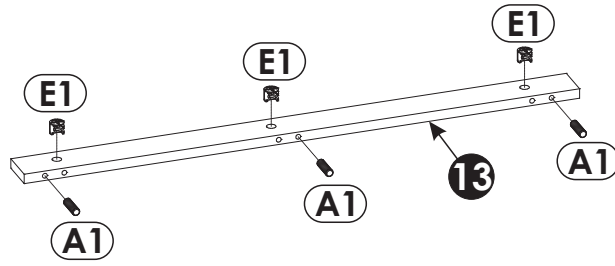
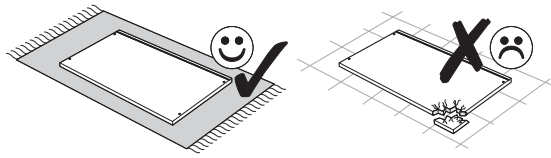

18▶

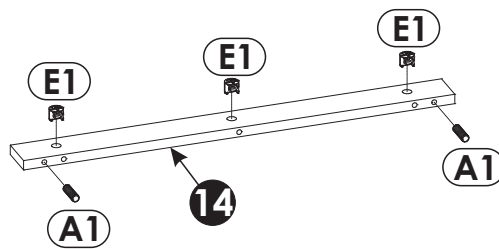
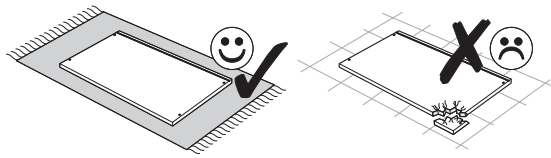

19 ▶▶

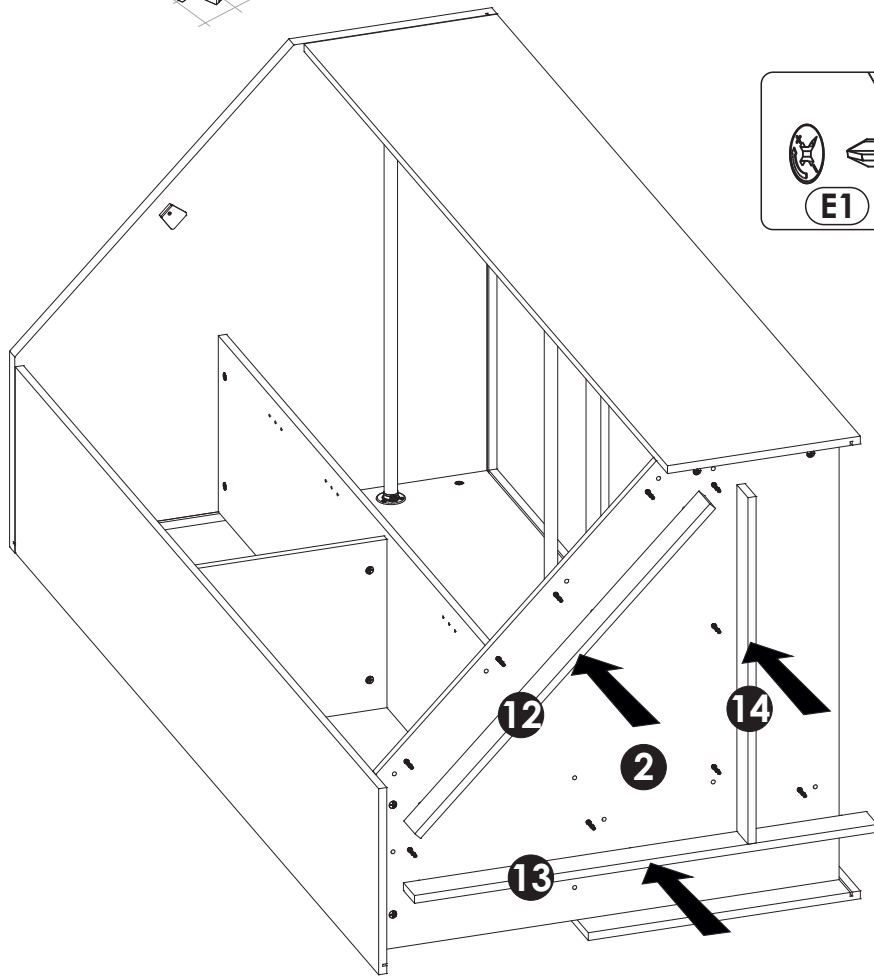
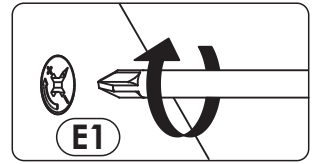
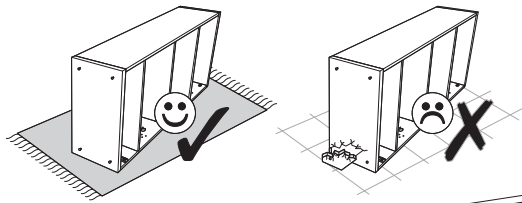

20 ▶▶

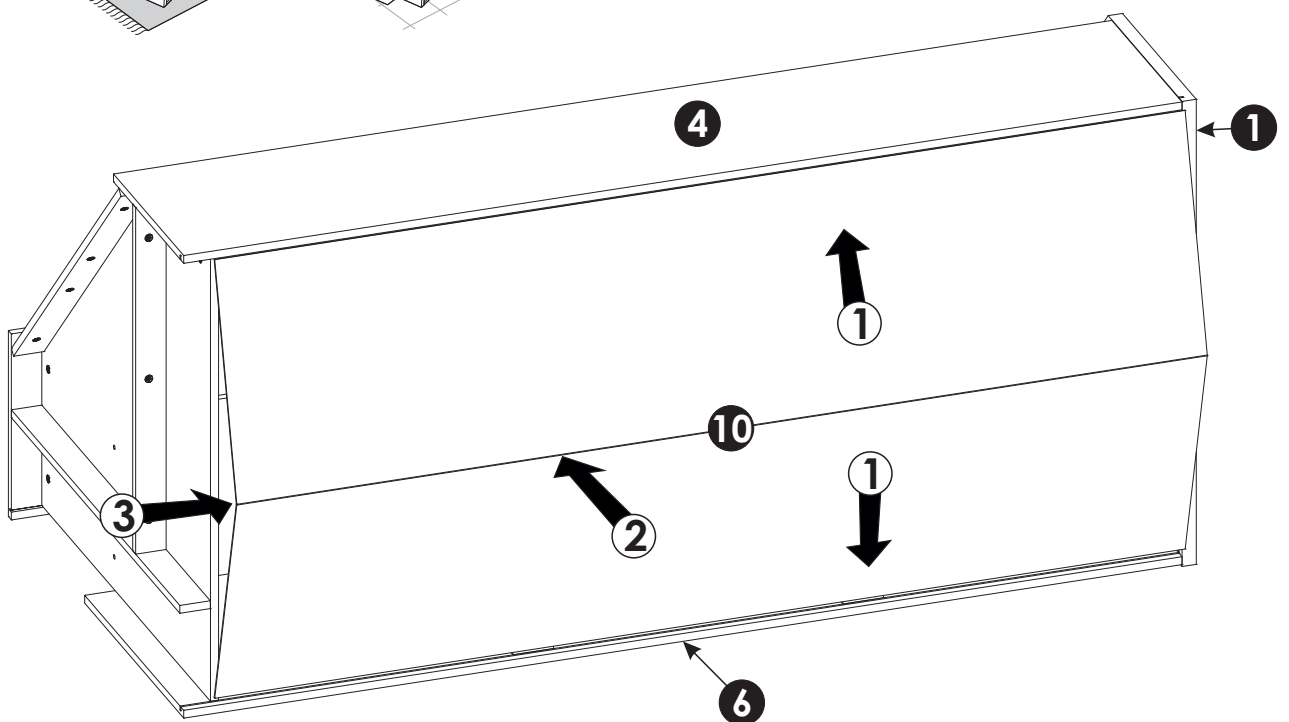
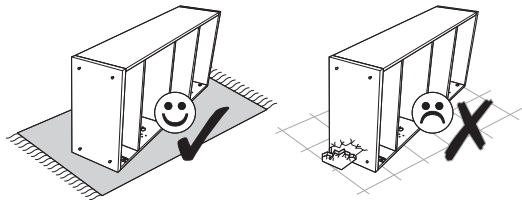

21 ▶

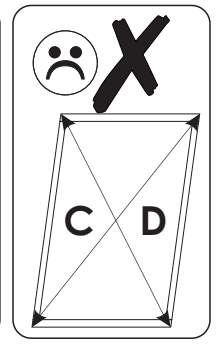
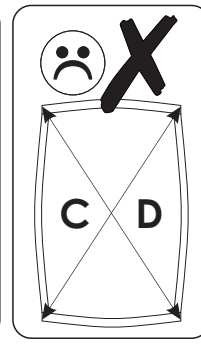
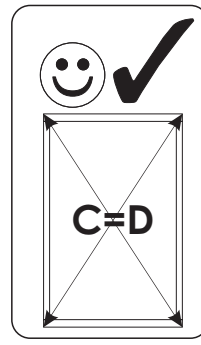
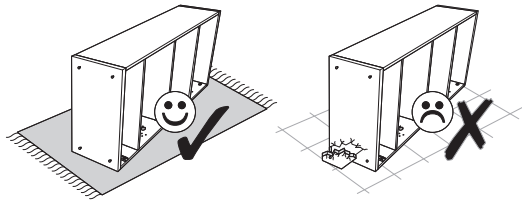

C=D

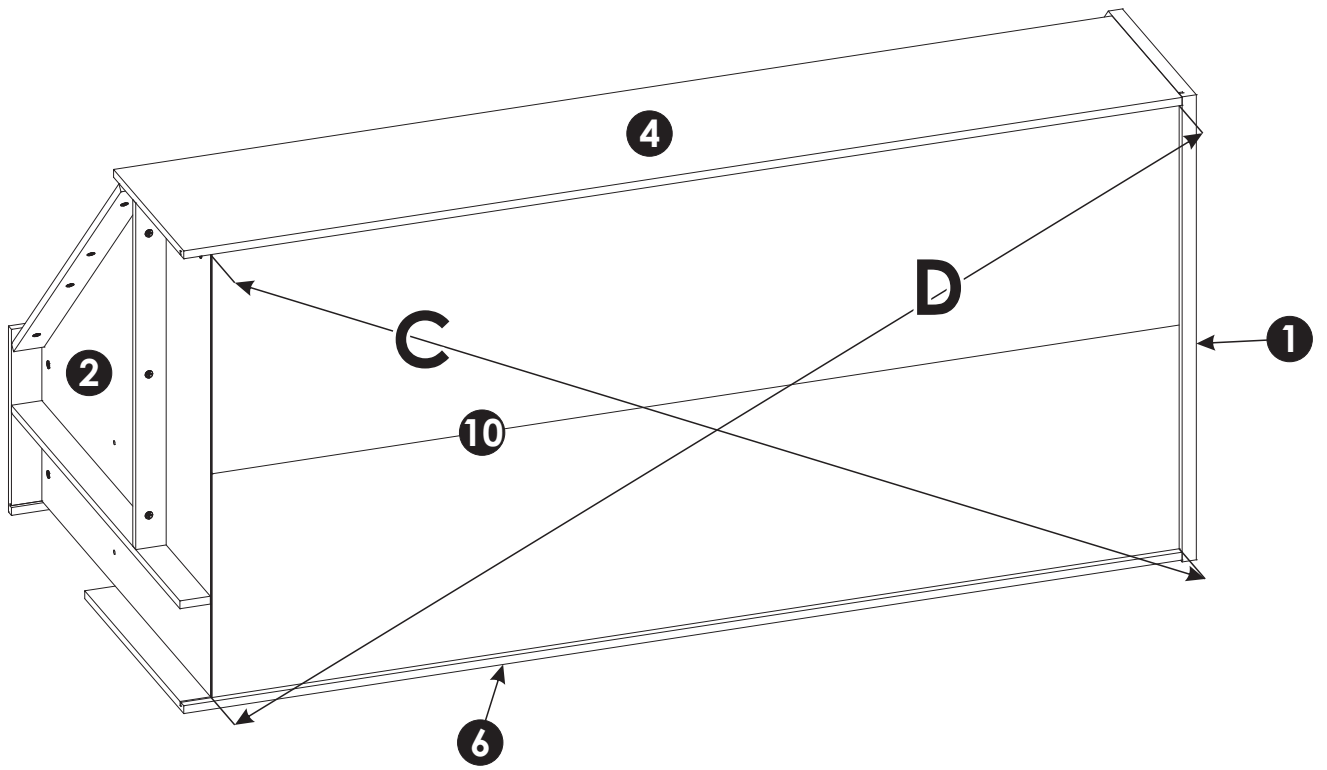

22 ▶

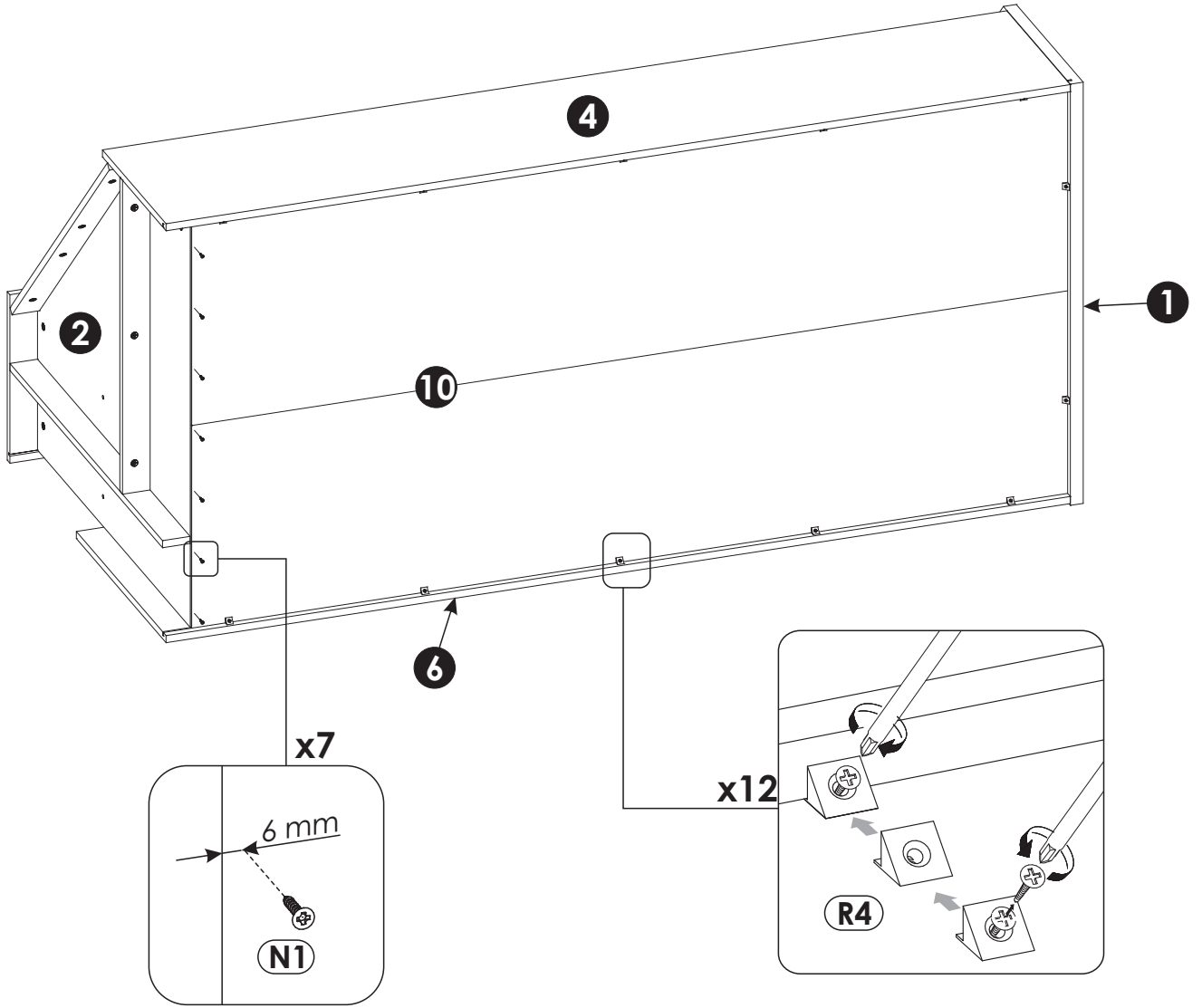
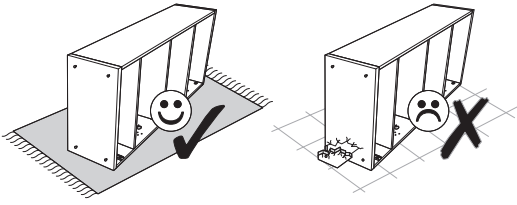

23 ▶

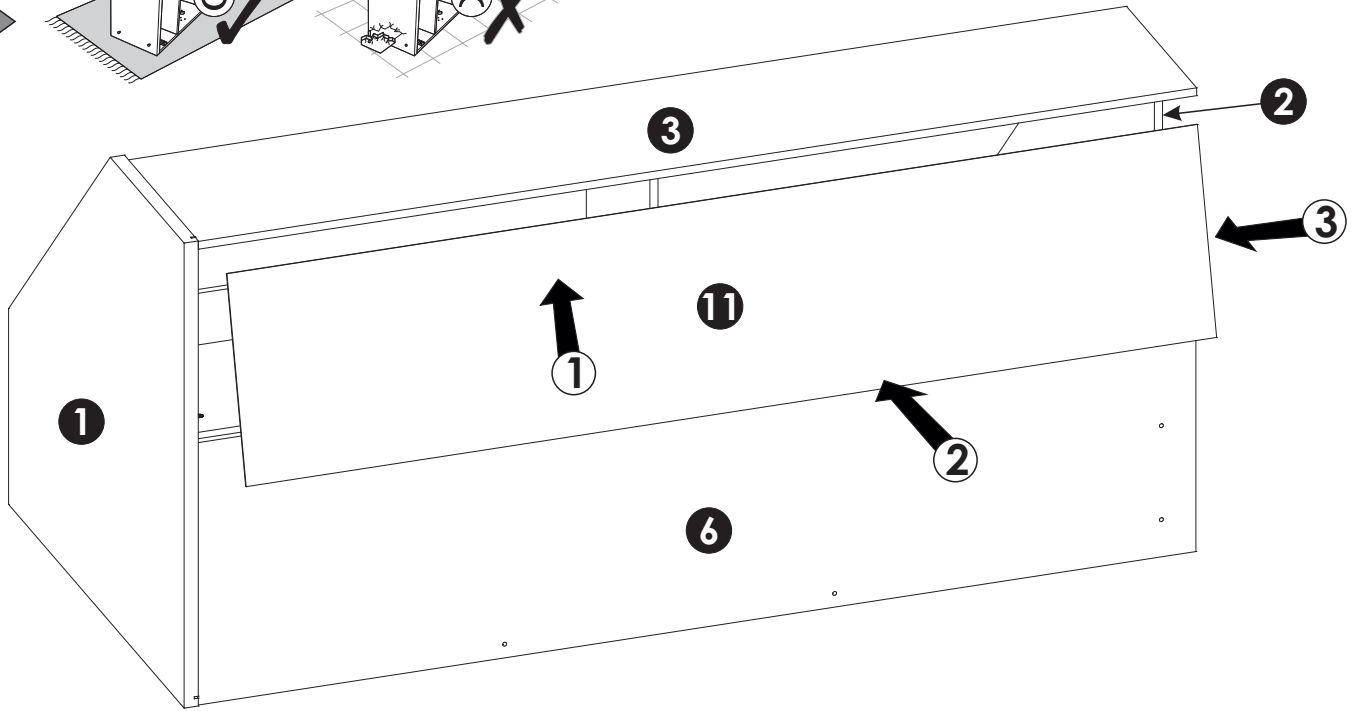
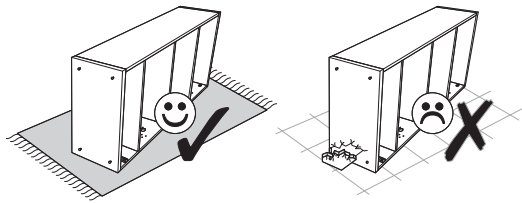

24 ▶

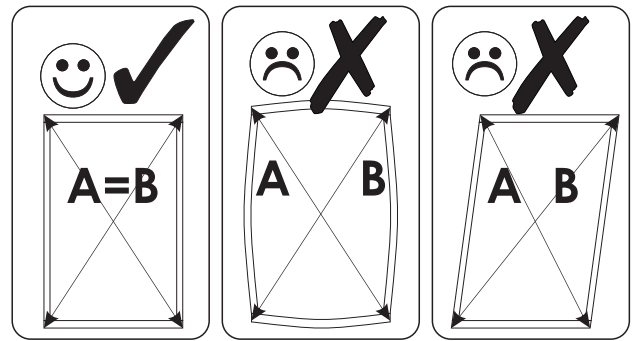
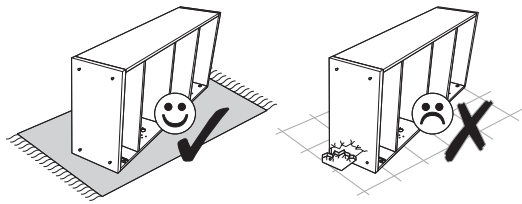

A=B

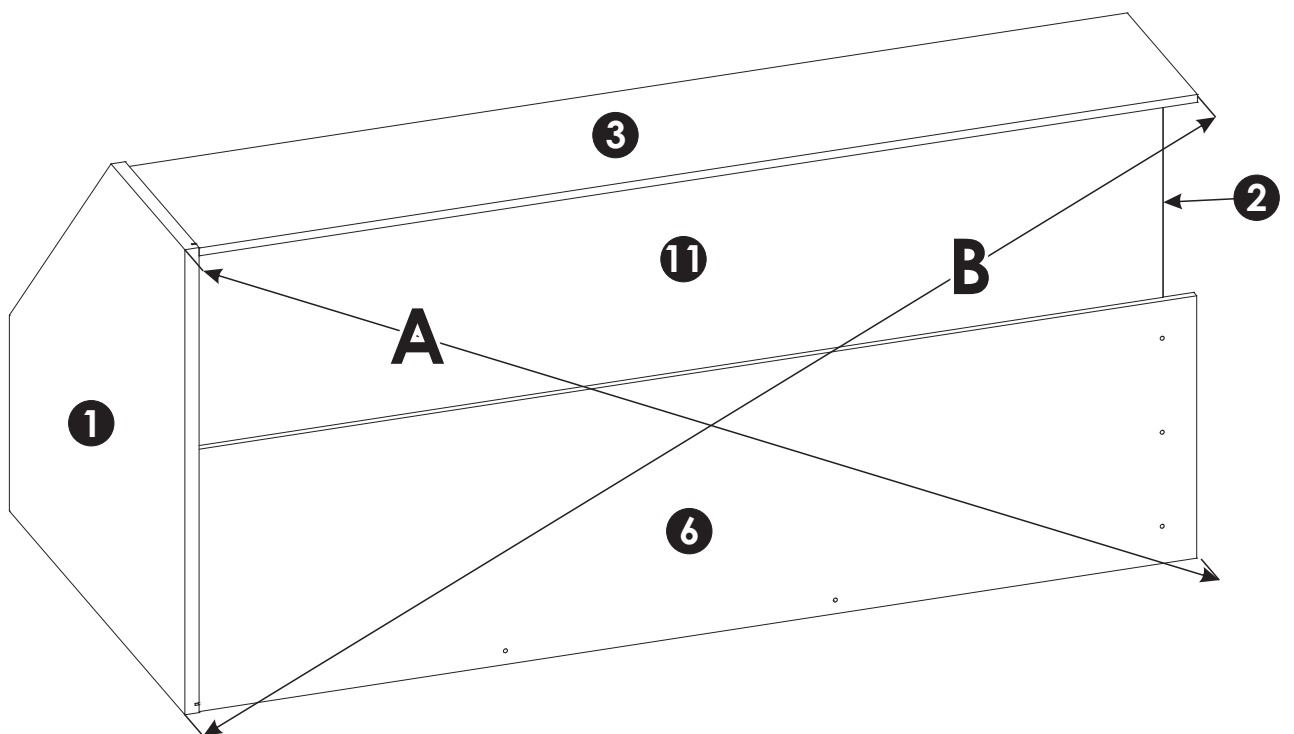

25 ▶

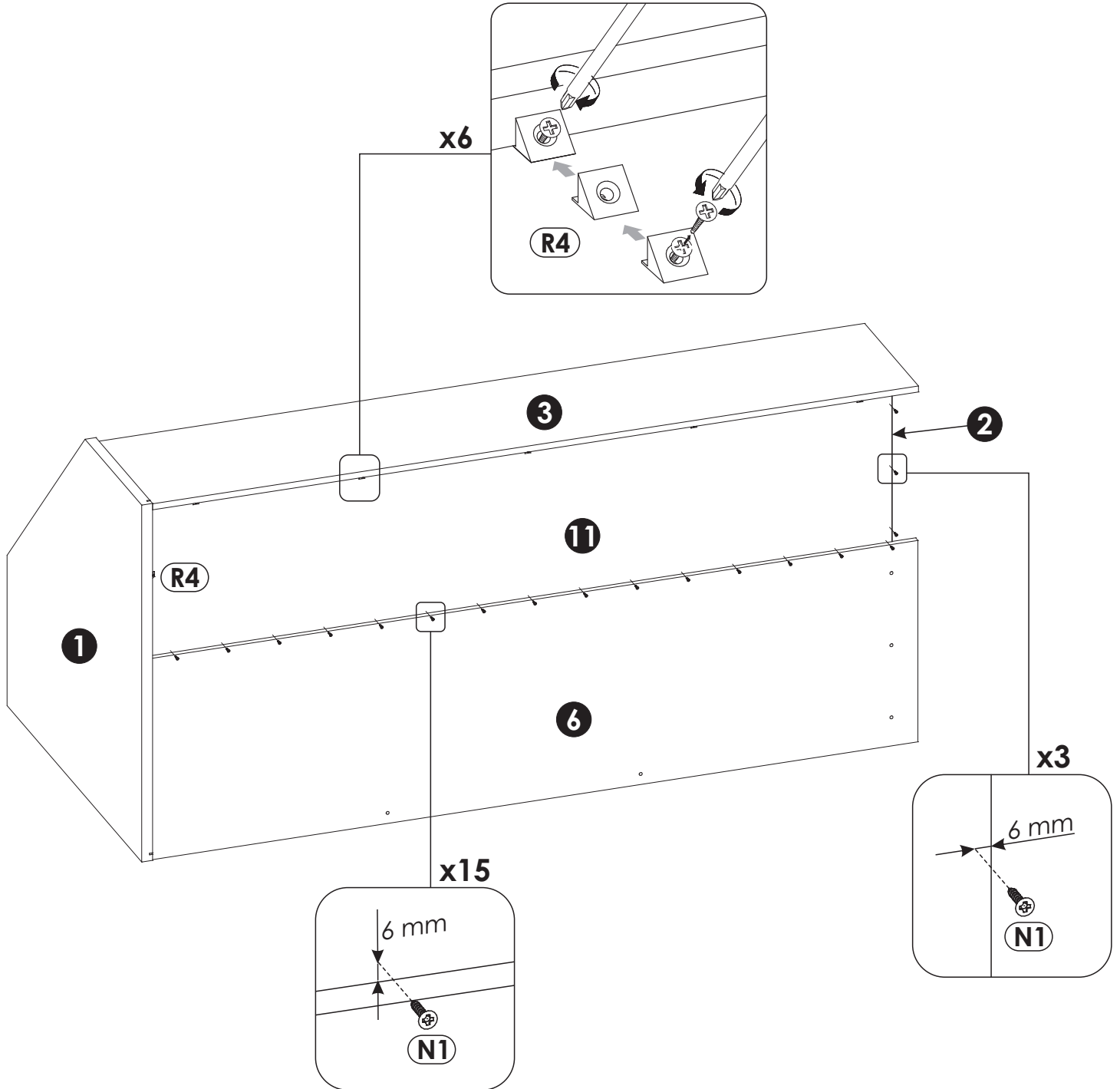
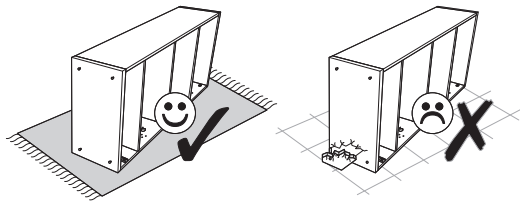

26 ▶

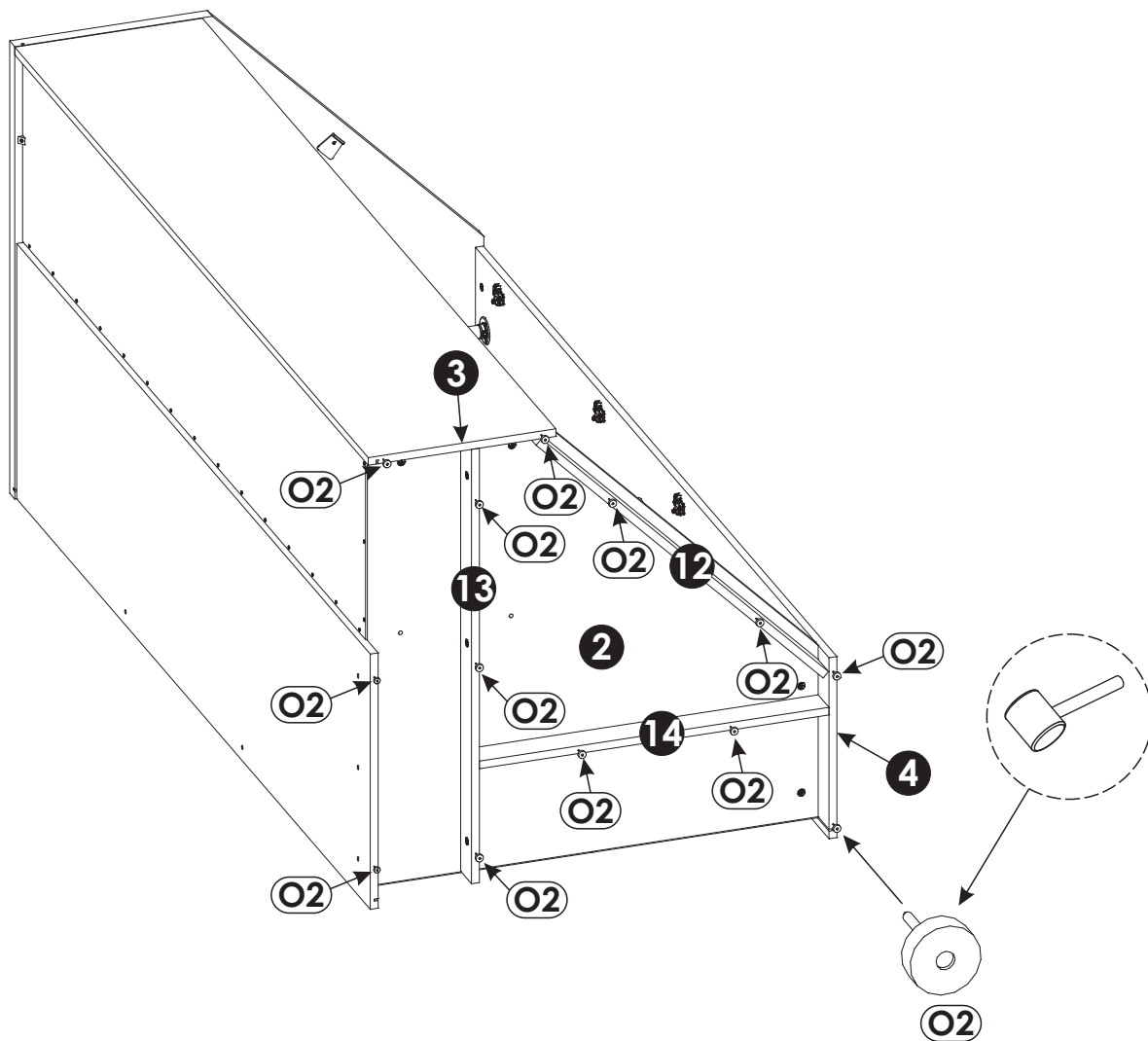
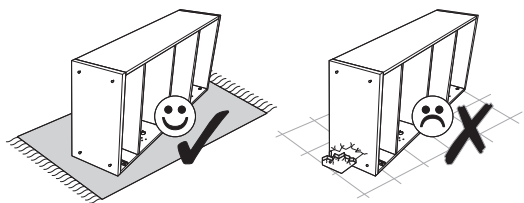

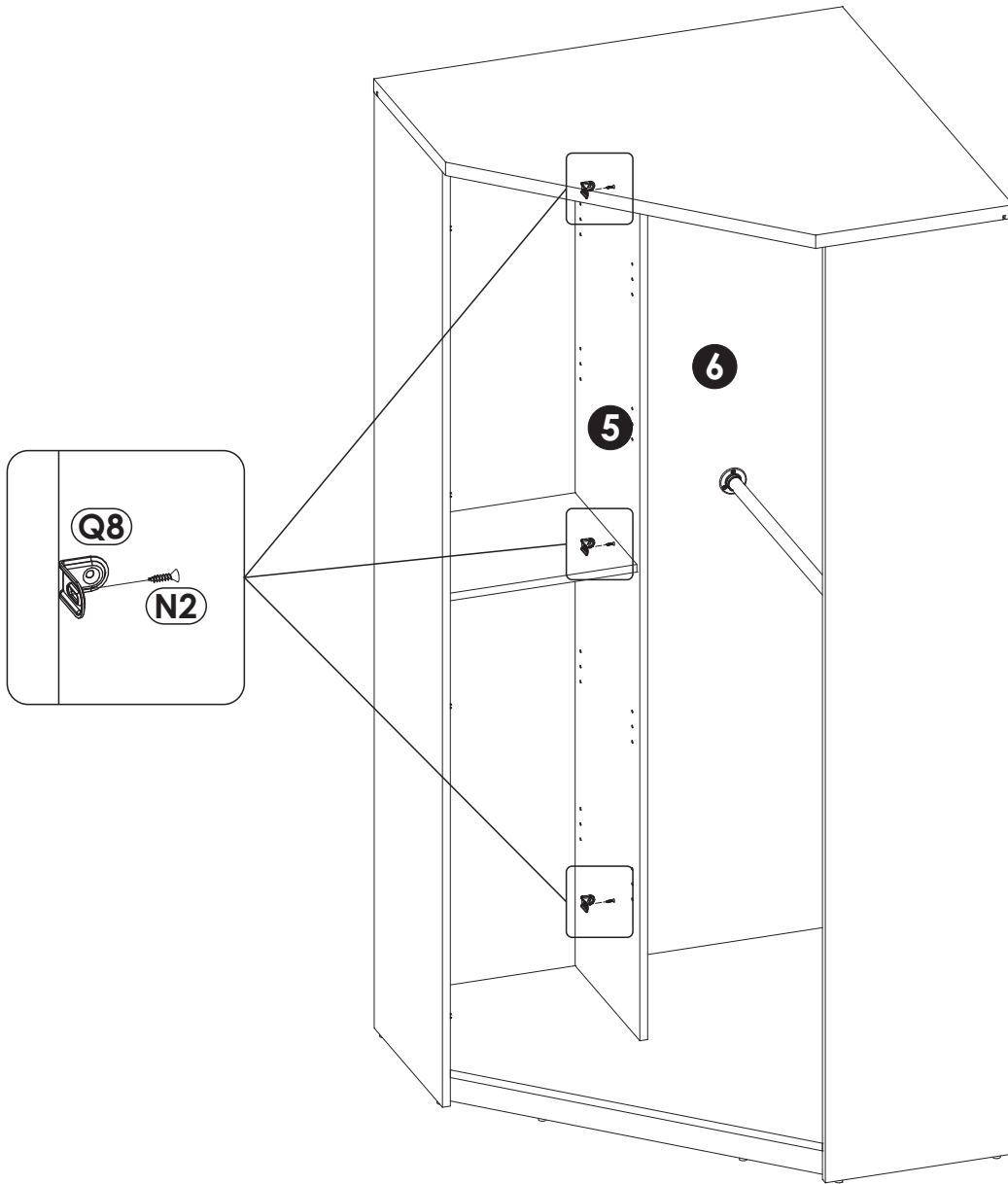

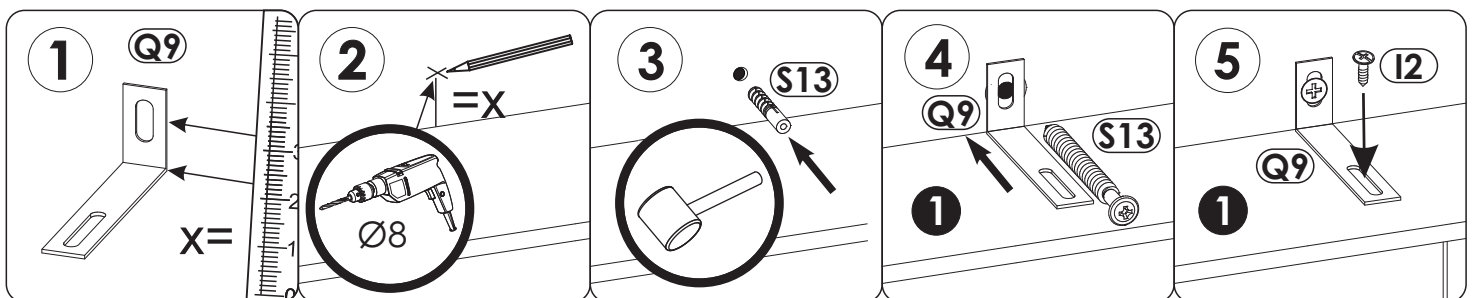
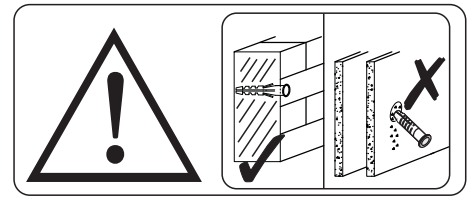
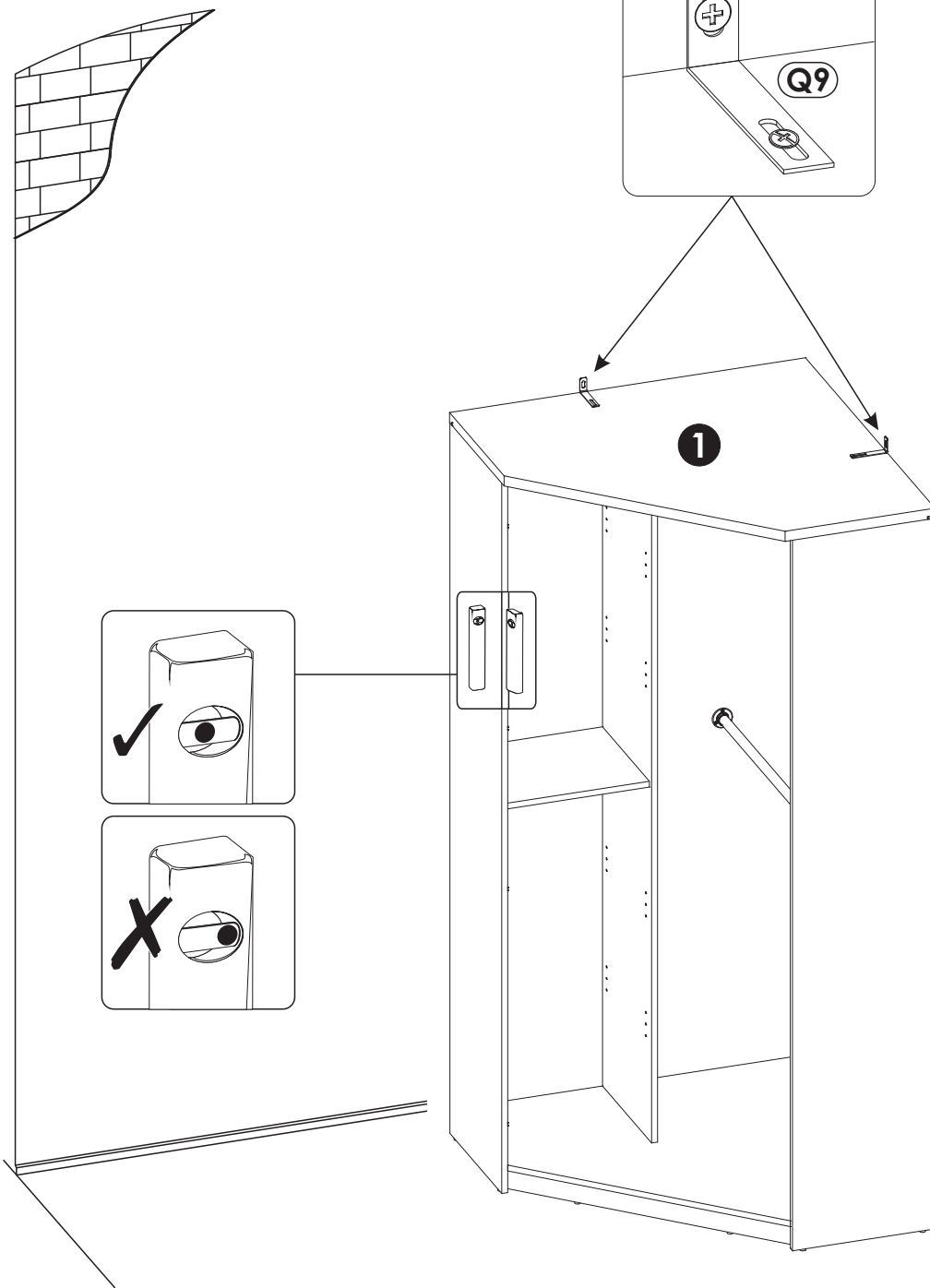

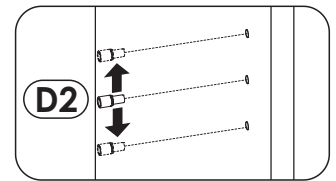
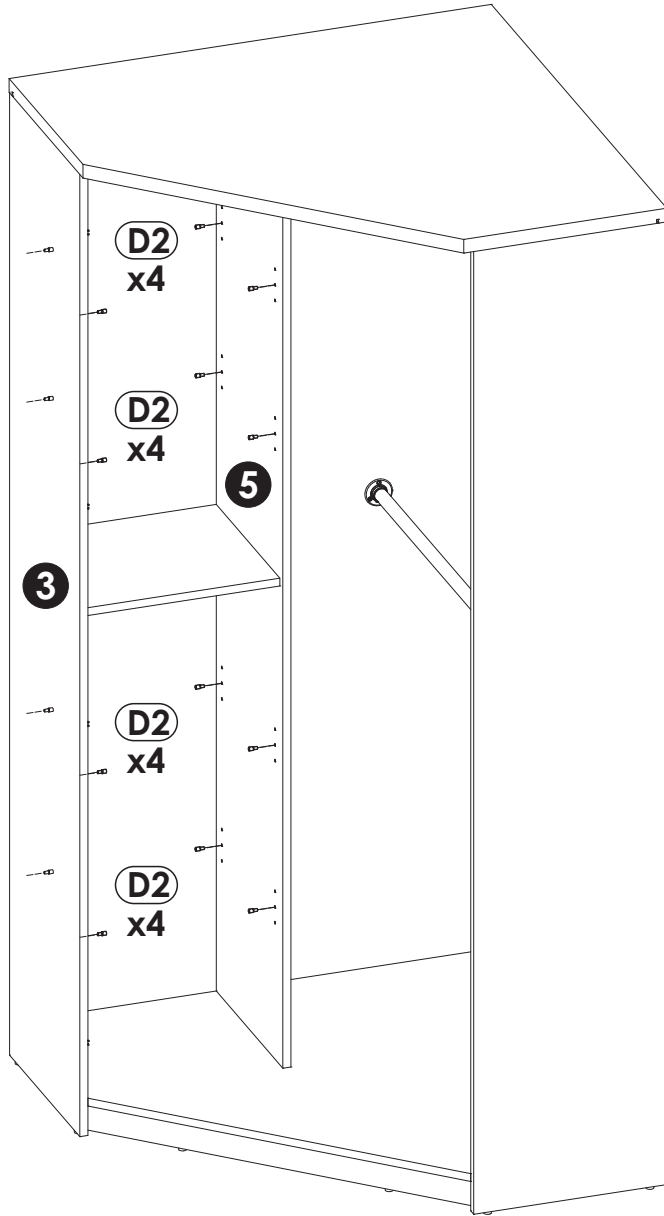

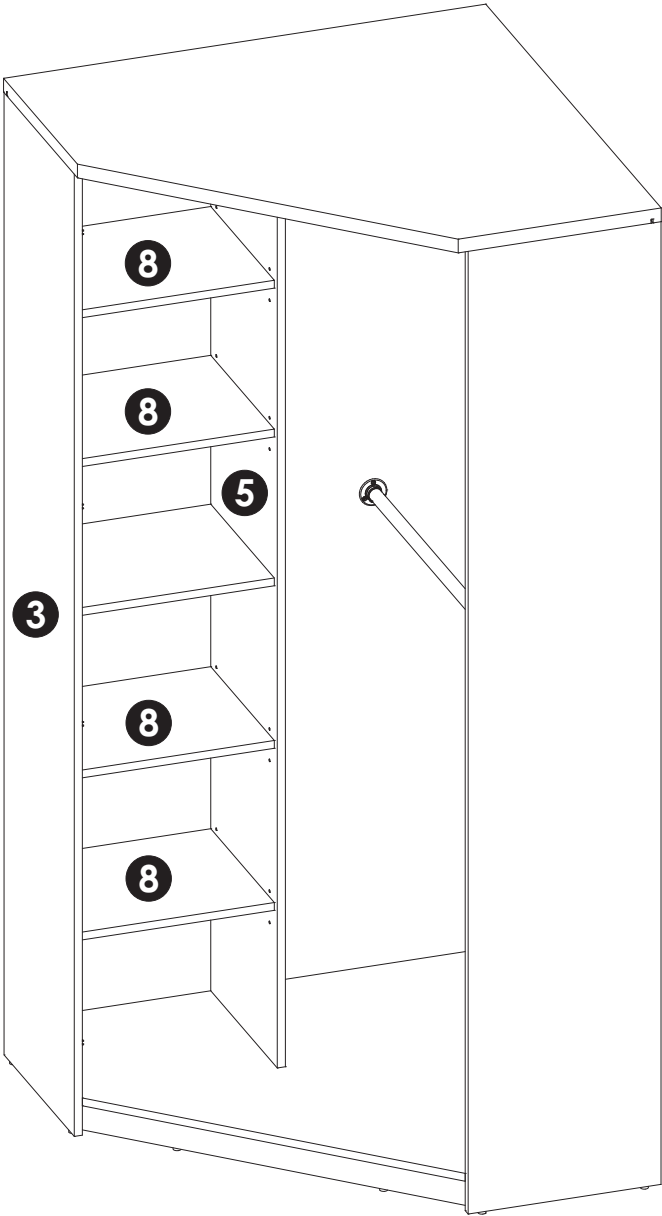
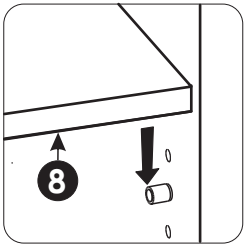

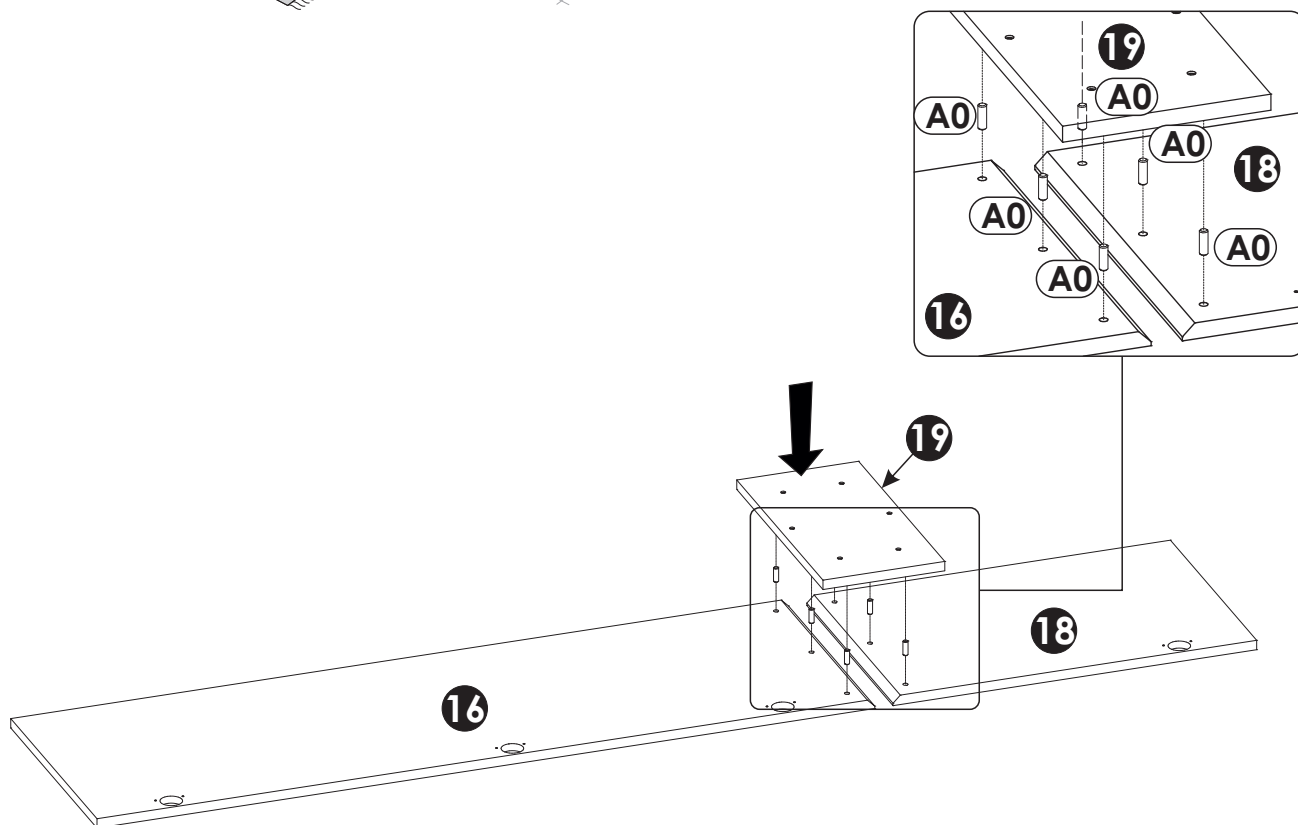
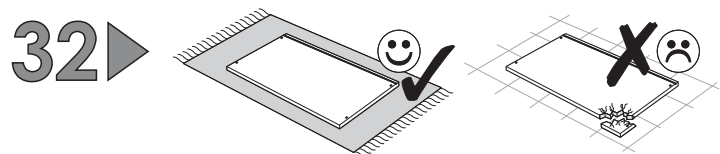
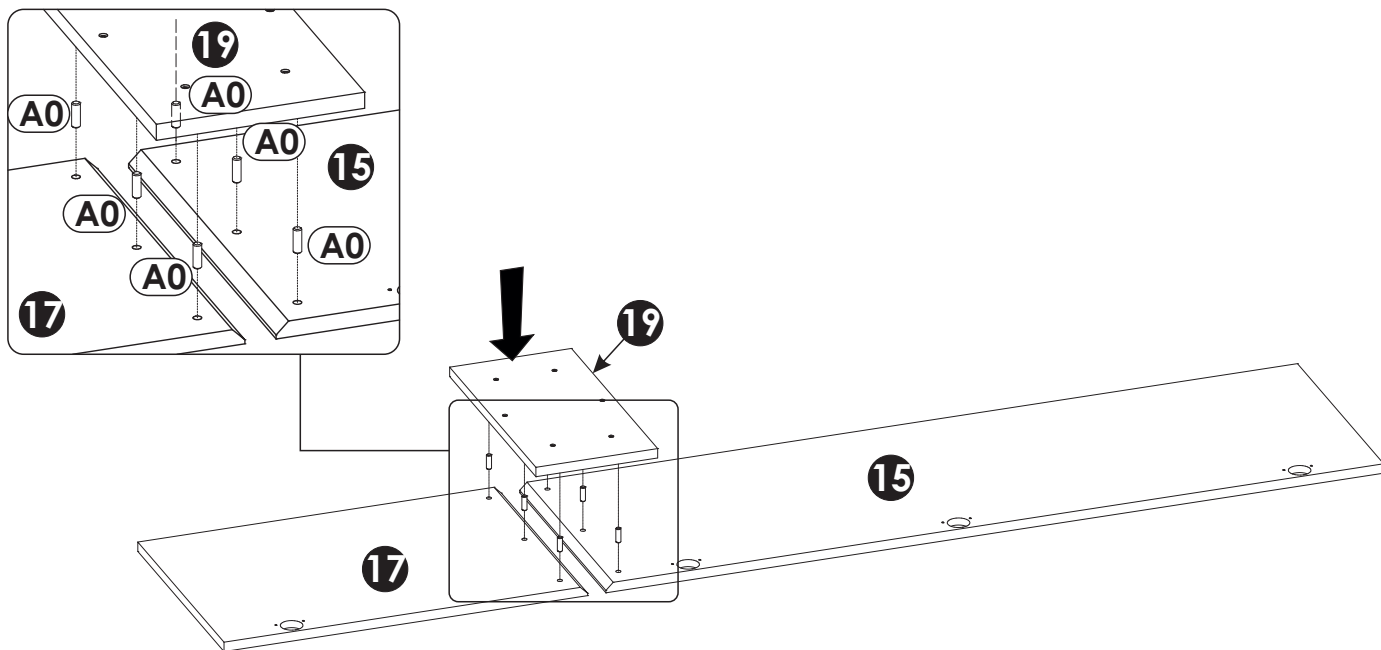
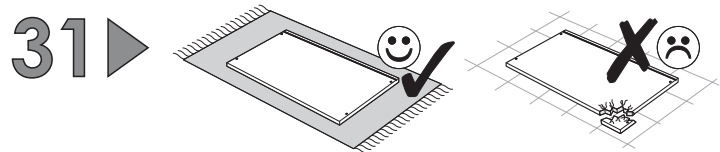

33 ▶

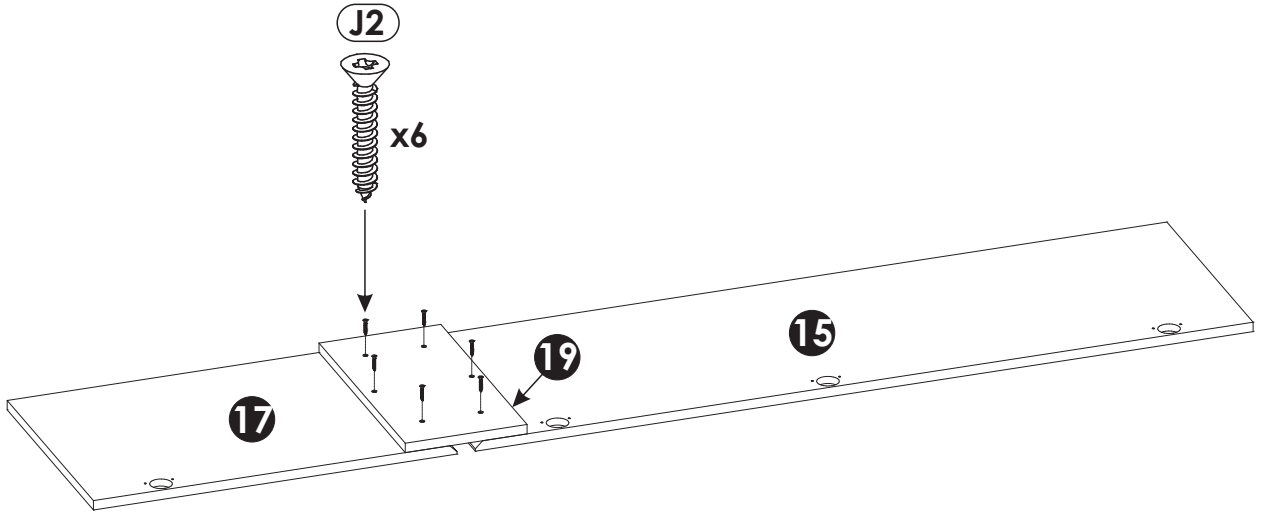
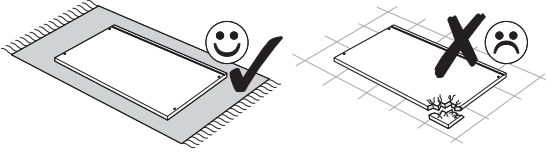

34 ▶

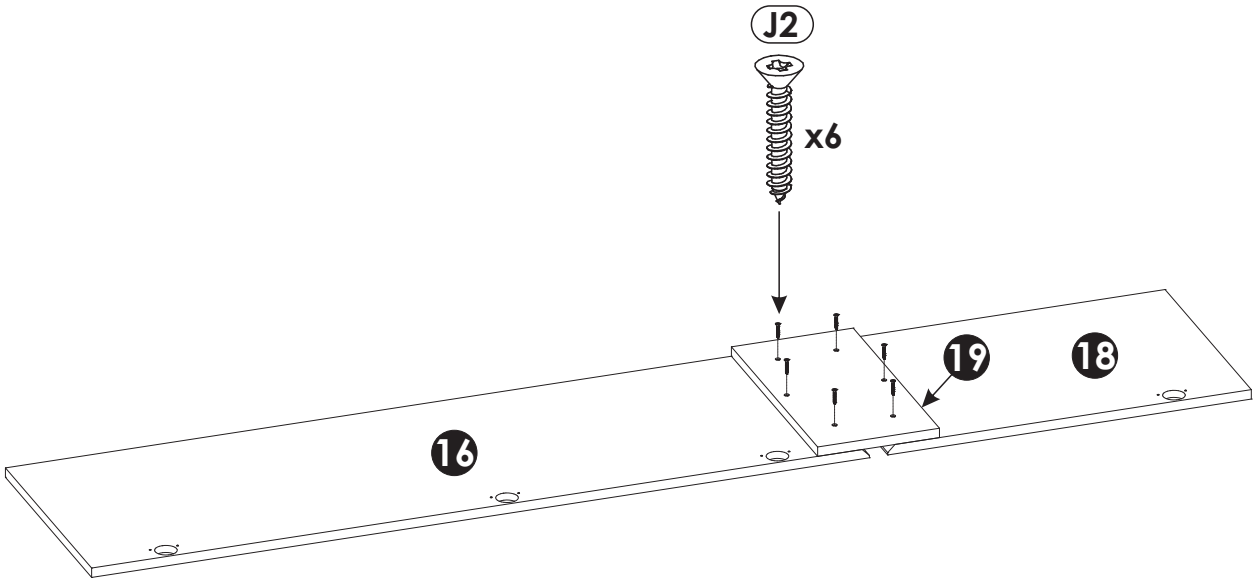
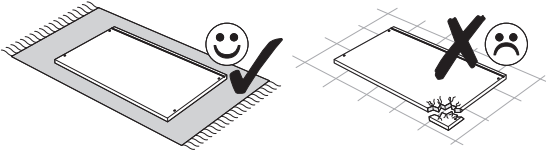

35 ▶

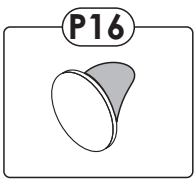
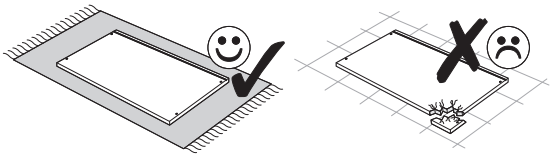

x6

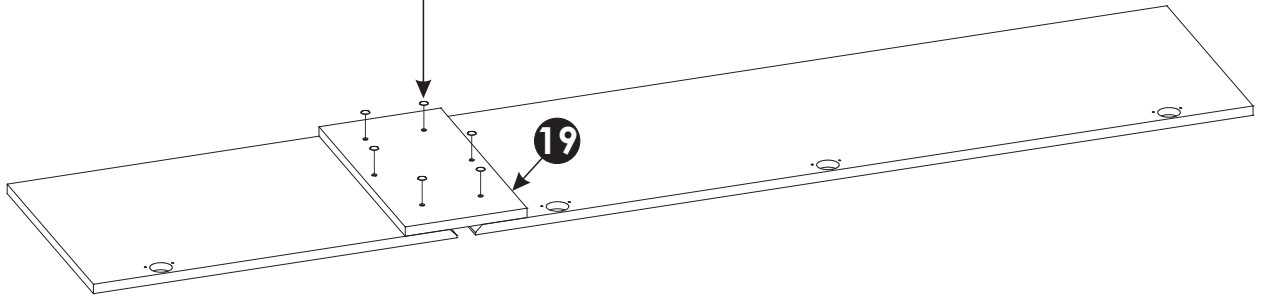

36 ▶

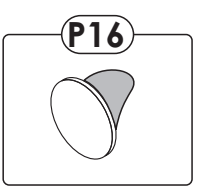
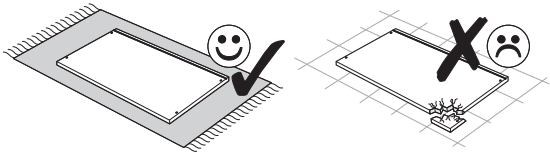

x6

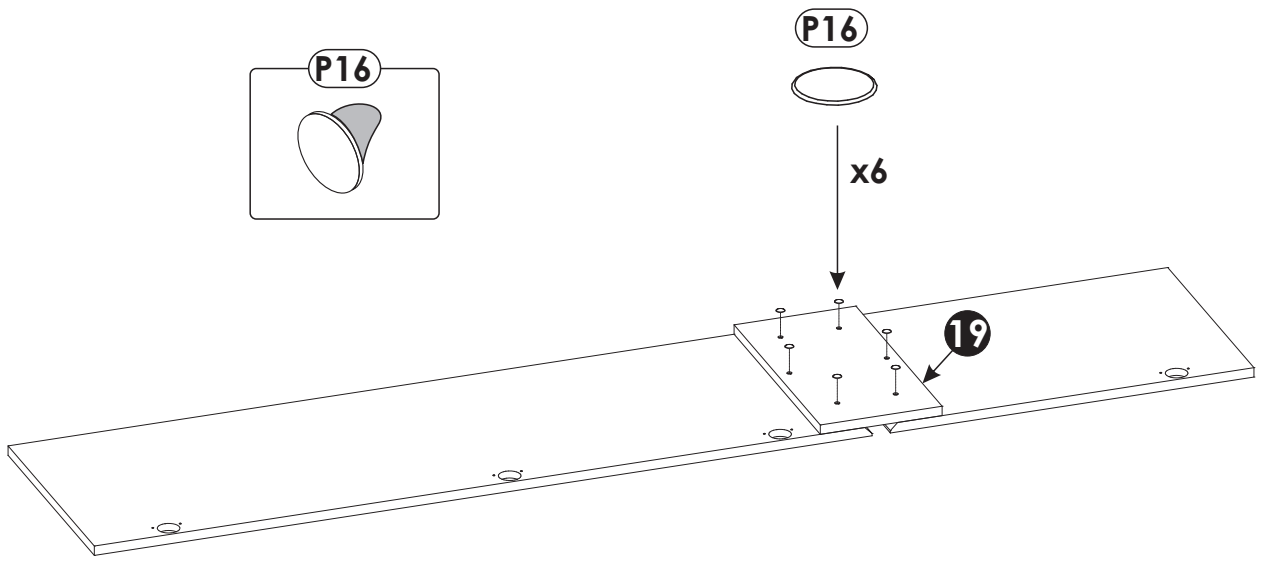

37 ▶

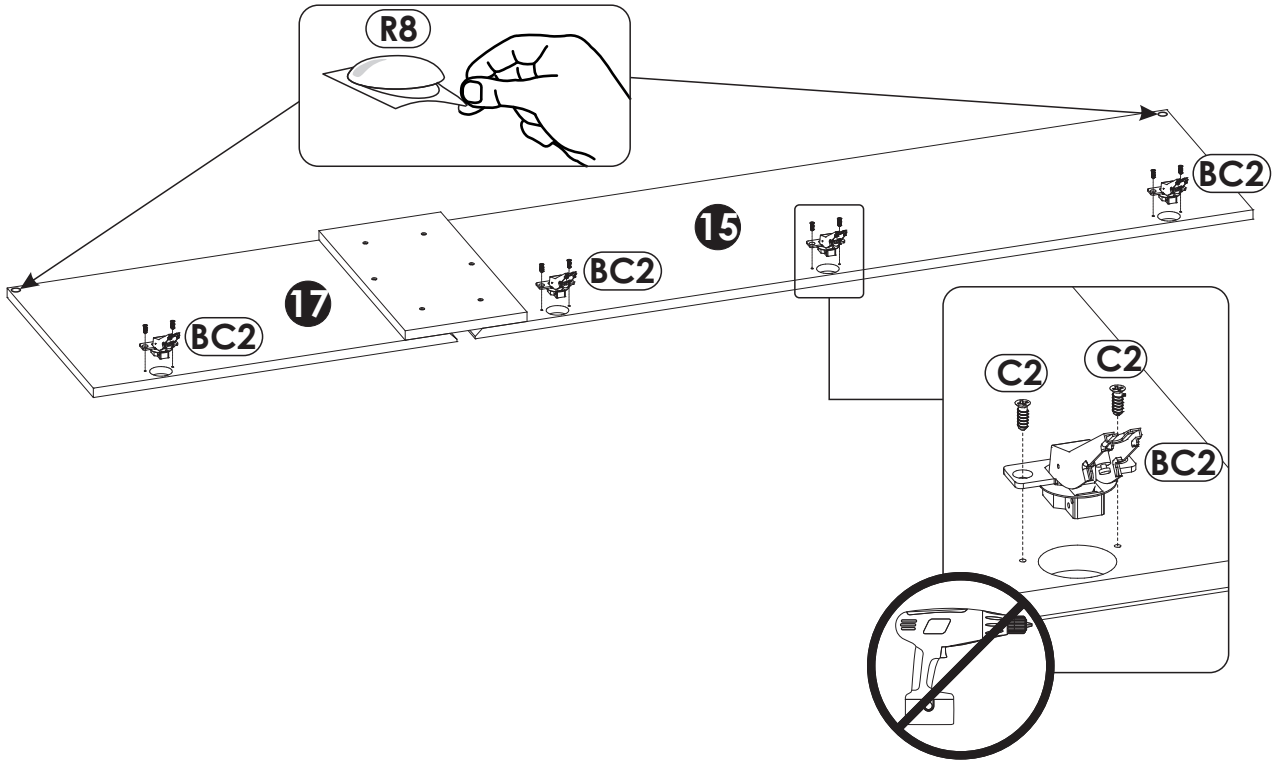
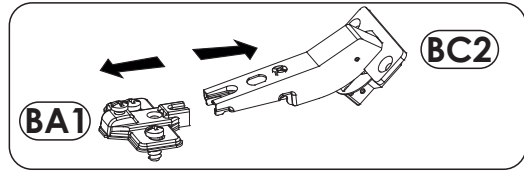
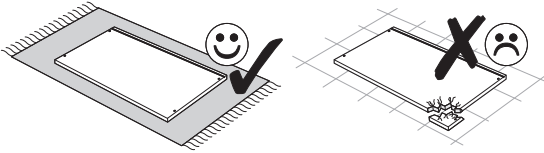

38 ▶

