

2022-03-15

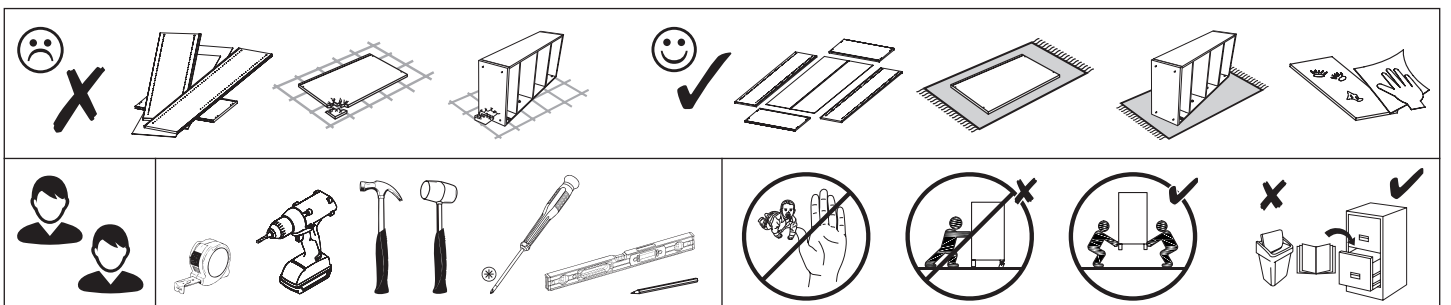

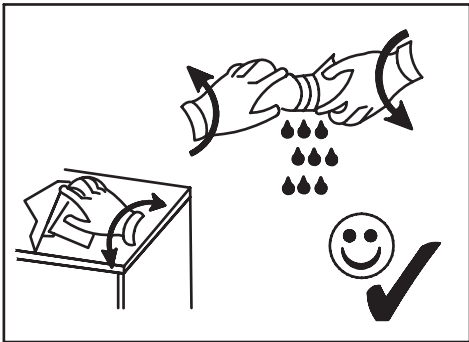

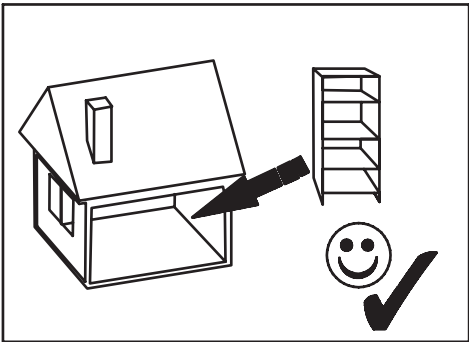
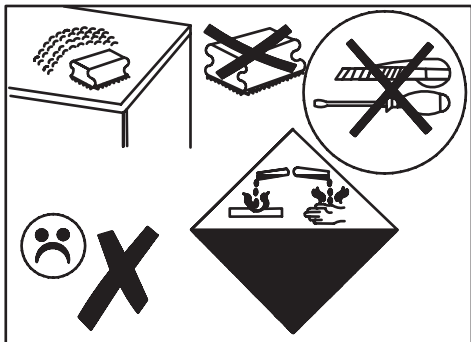
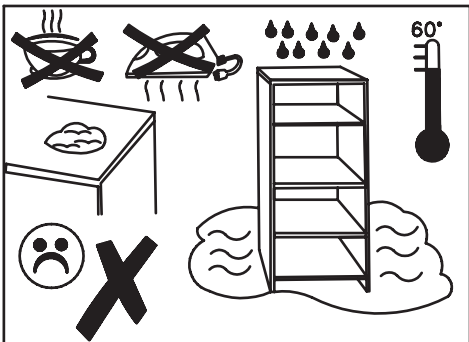
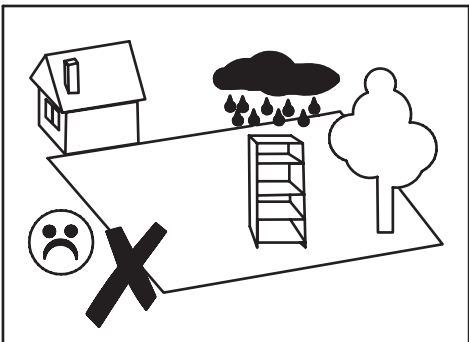
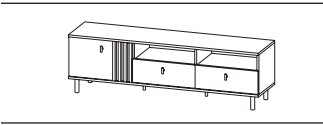
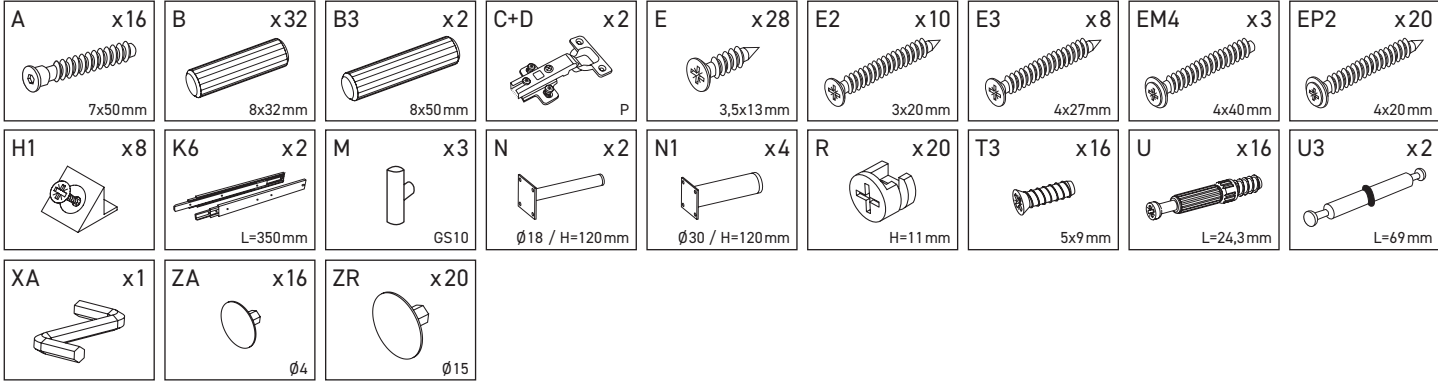
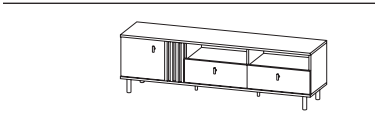

B-1a	1651	400	16	x 1	1/1
B-1b	1651	400	16	x 1	1/1
B-2	340	380	16	x 1	1/1
B-3	340	380	16	x 1	1/1
B-4	340	365	16	x 1	1/1
B-5	340	365	16	x 1	1/1
B-6	526	365	16	x 2	1/1
B-7a	547	200	16	x 1	1/1
B-7b	547	200	16	x 1	1/1
B-8a	350	120	16	x 1	1/1
B-8b	350	120	16	x 1	1/1
B-9	470	120	16	x 2	1/1
B-10	334	378	16	x 1	1/1
B-11	340	186	16	x 1	1/1
B-12	340	24	18	x 4	1/1
B-13	470	120	3	x 1	1/1
B-14	1632	684	3	x 1	1/1

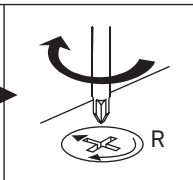
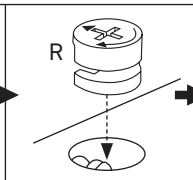
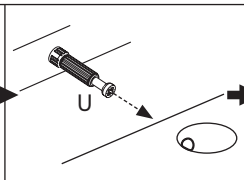
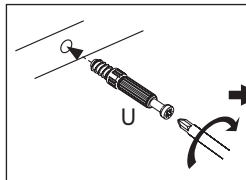
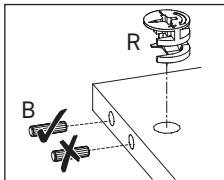
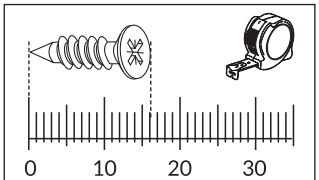
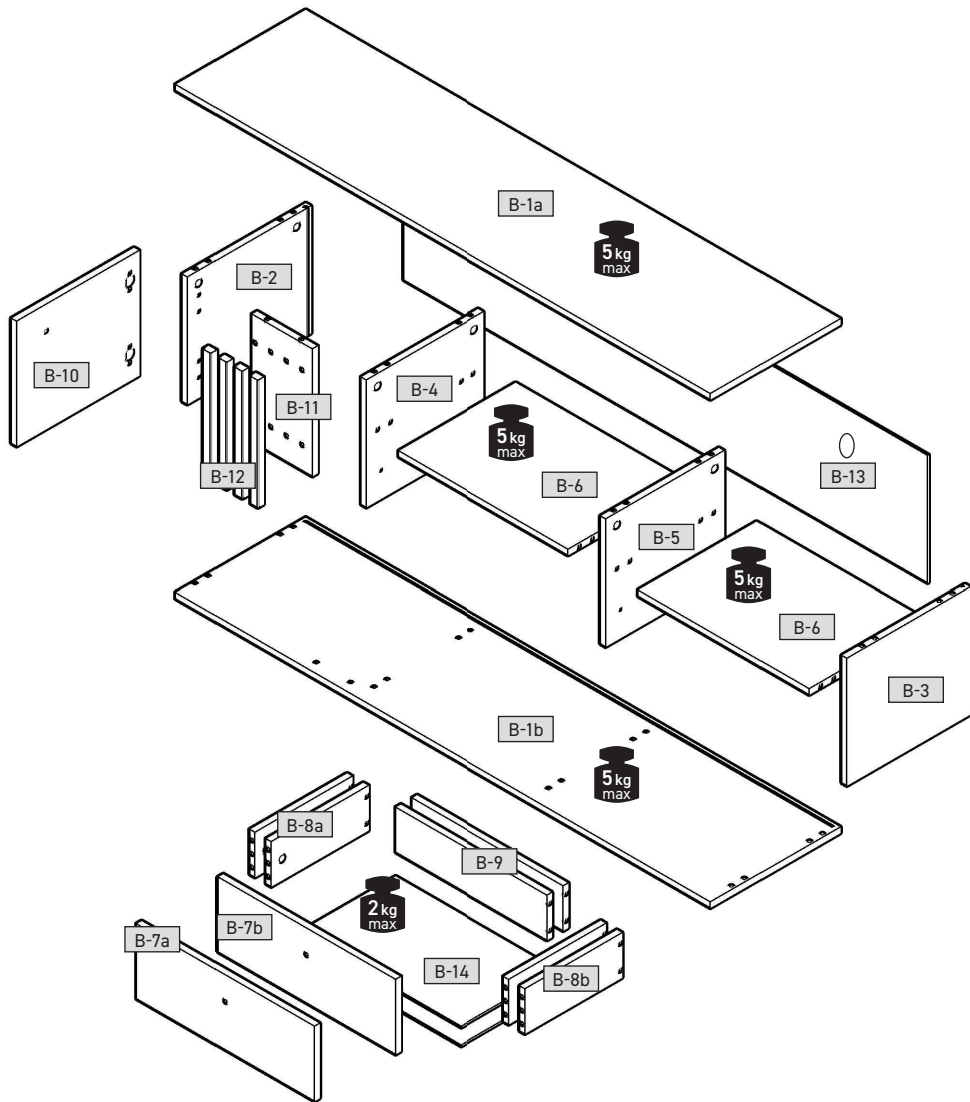

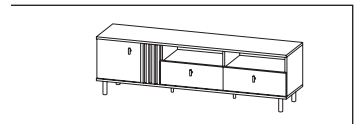

1

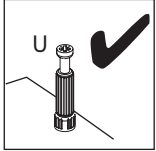
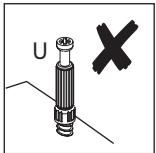
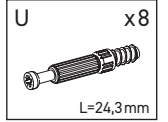
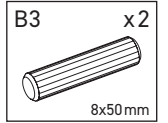
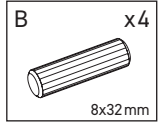
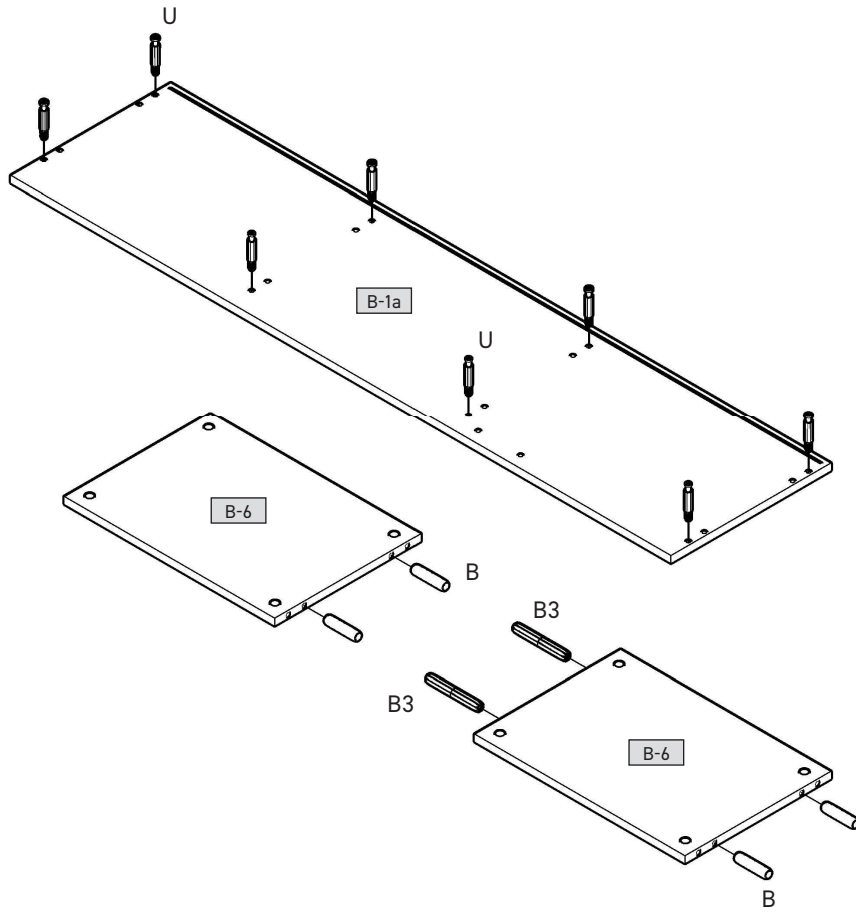

2

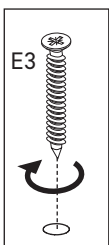
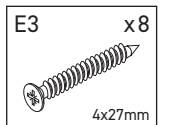
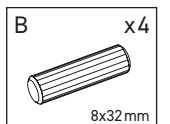
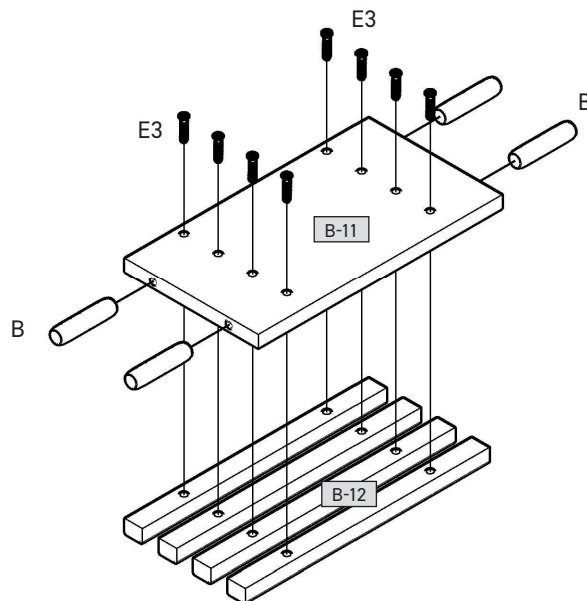

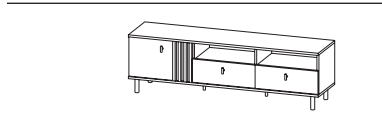

3

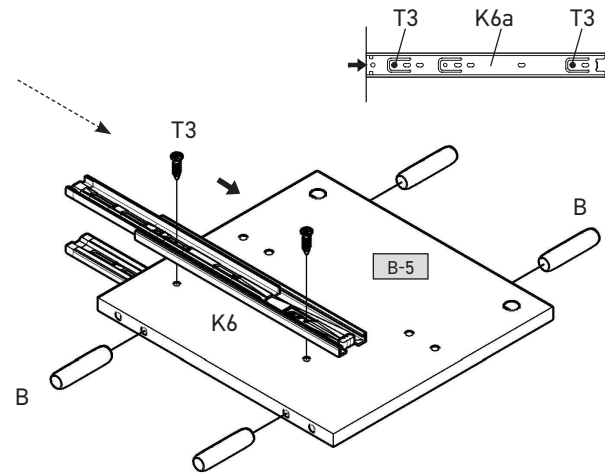
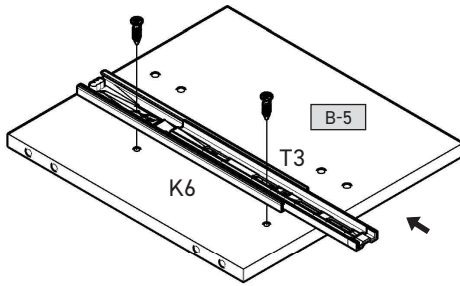
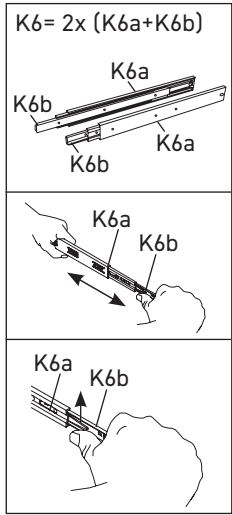
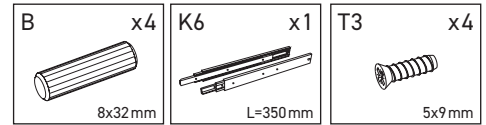
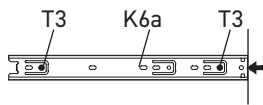
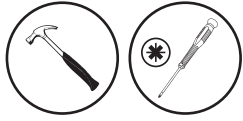

4

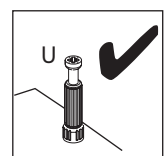
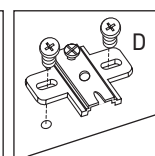
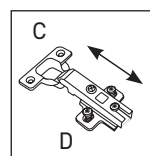
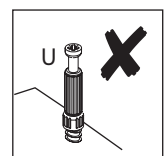
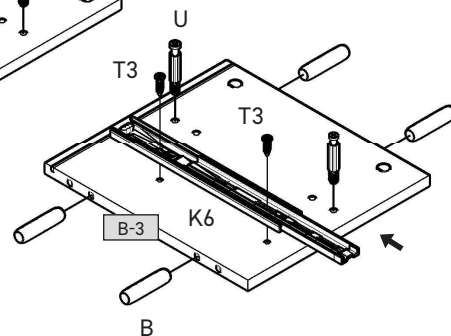
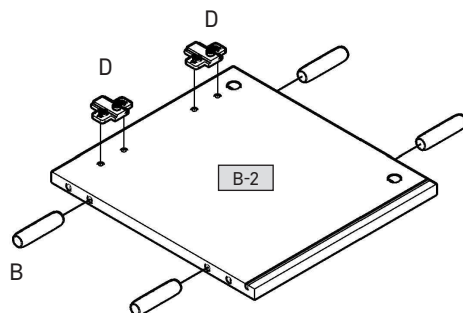
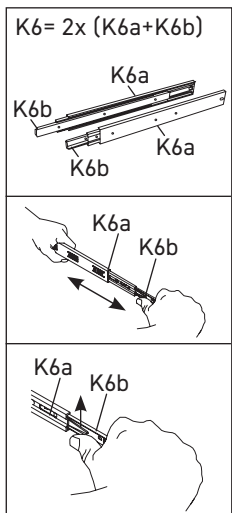
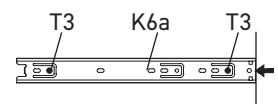
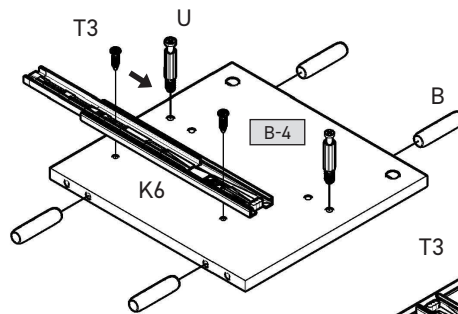
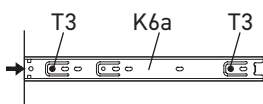
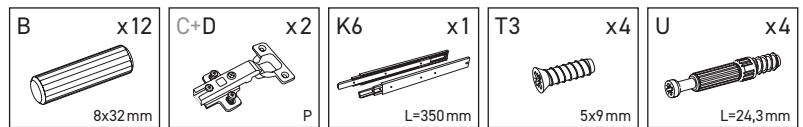

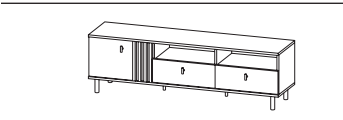

5

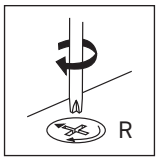
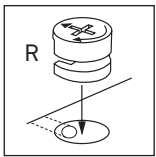
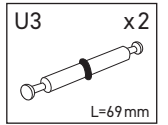
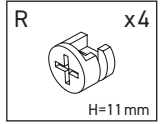
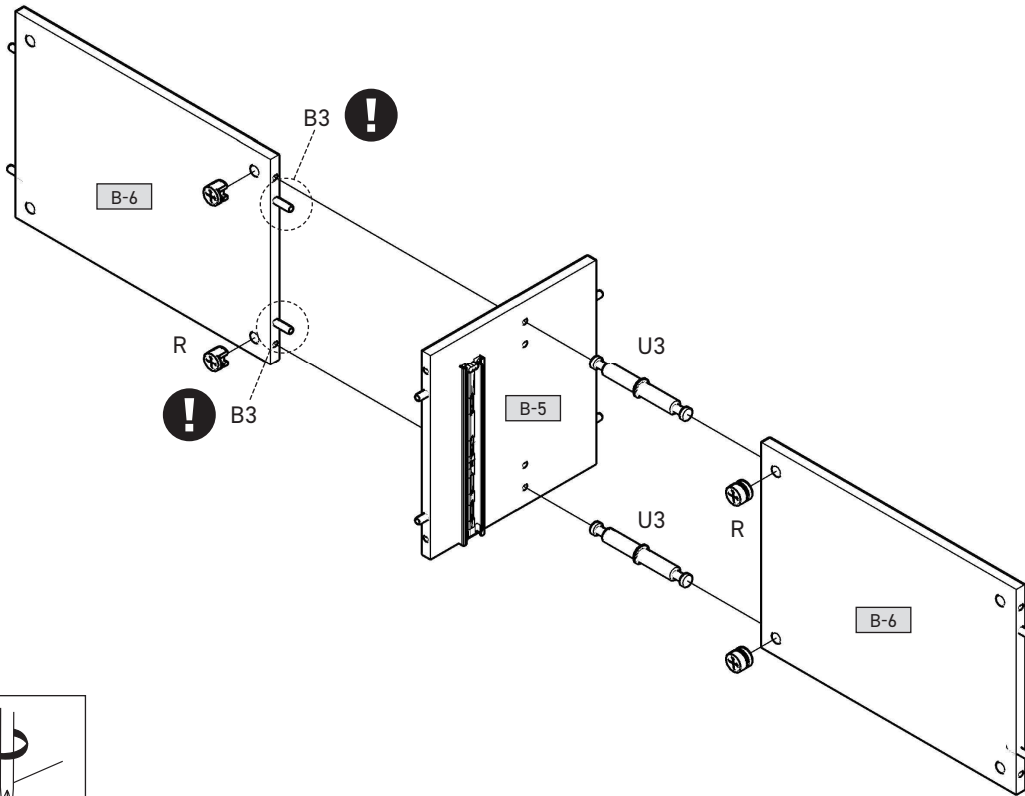

6

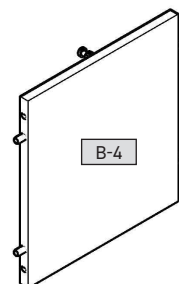
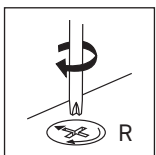
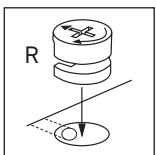
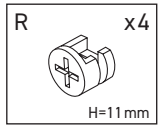
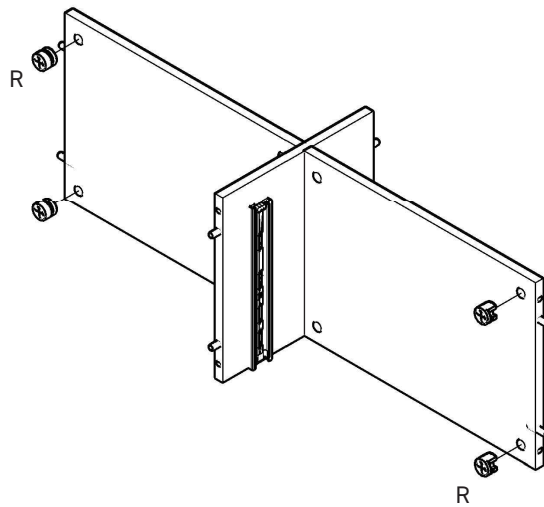
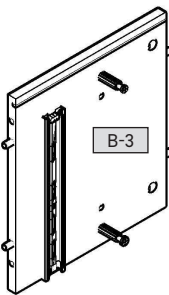

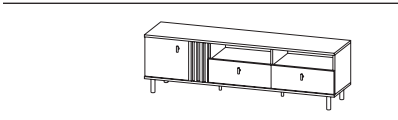

7

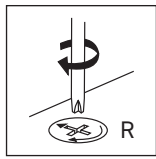
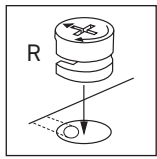
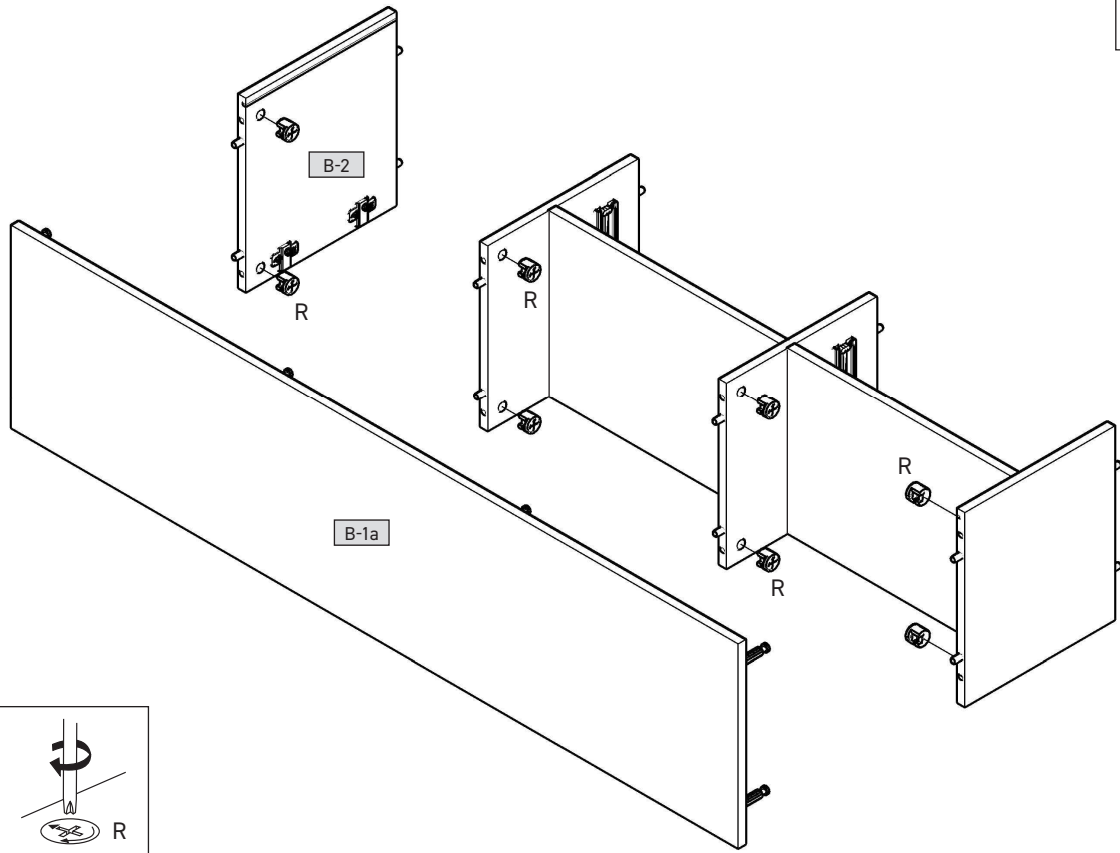
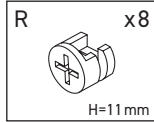

8

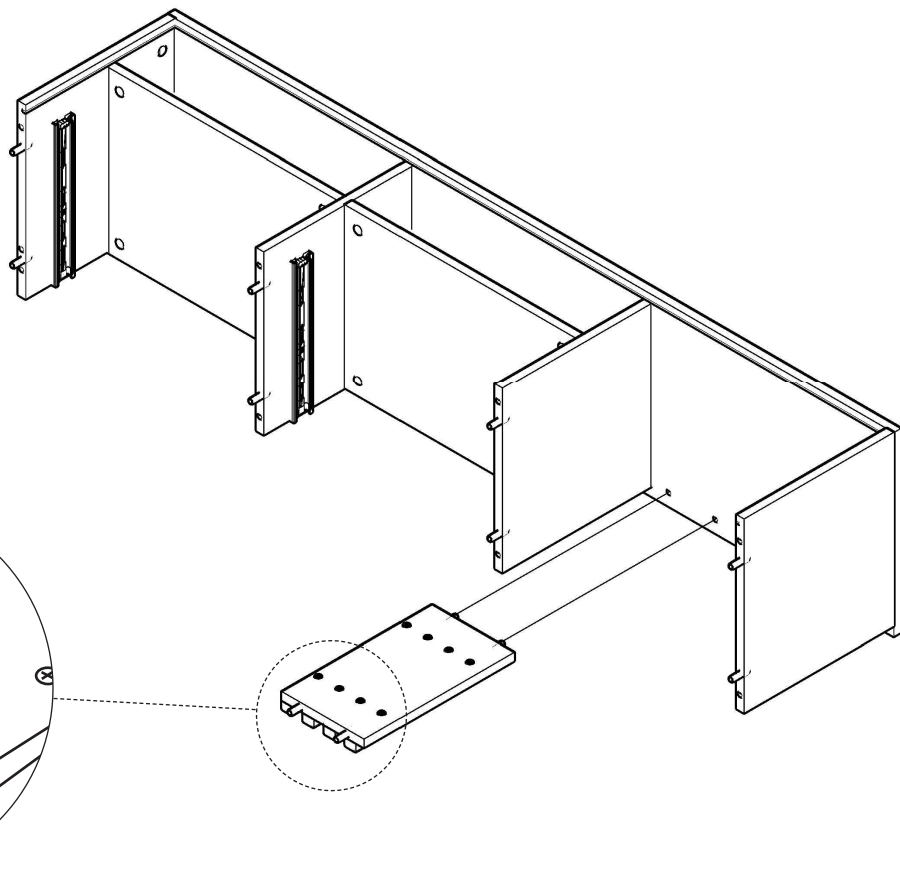

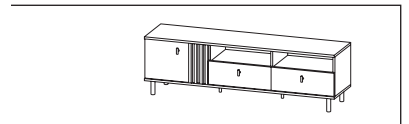

9

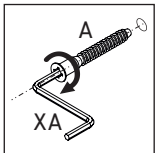
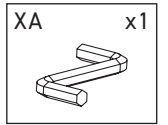
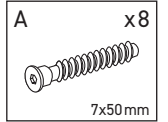
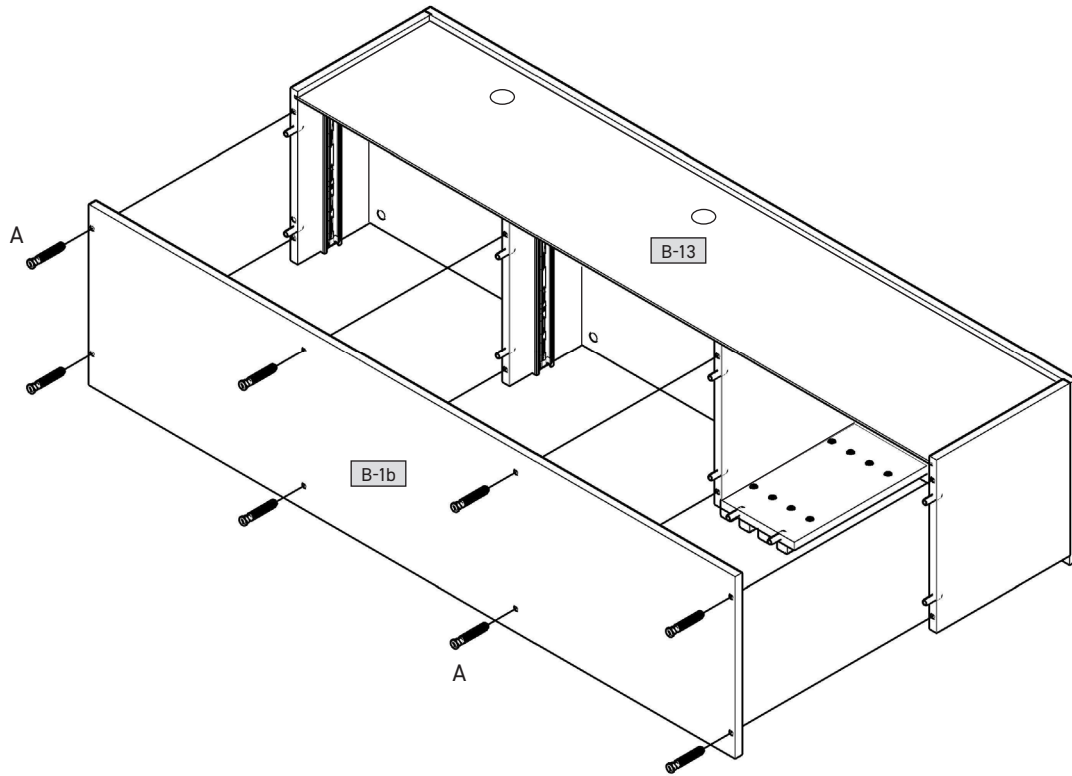

10

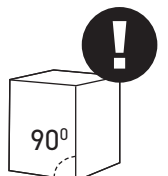
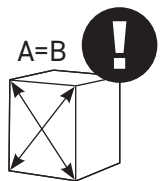
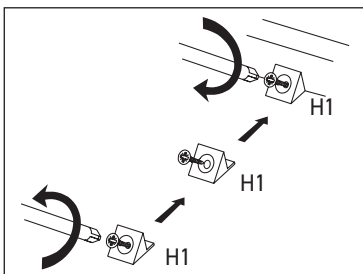
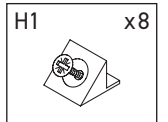
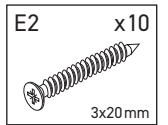
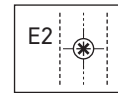
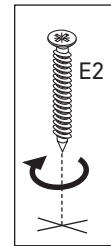
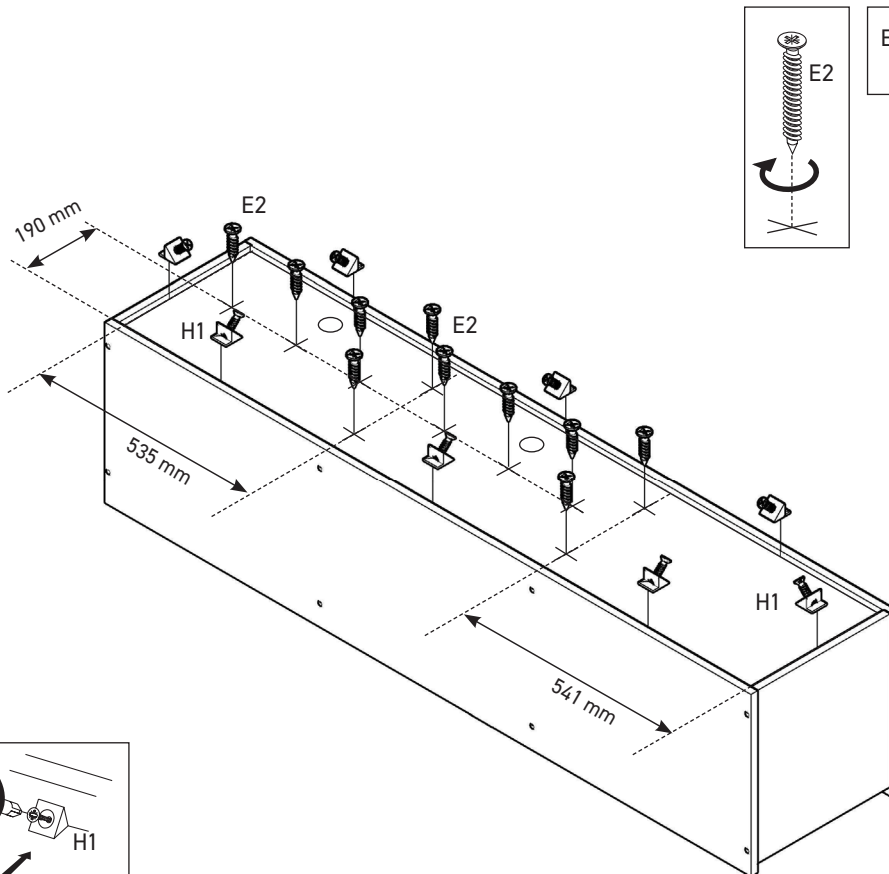

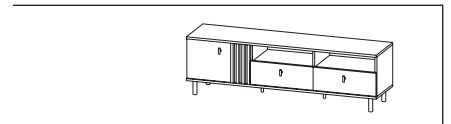

11

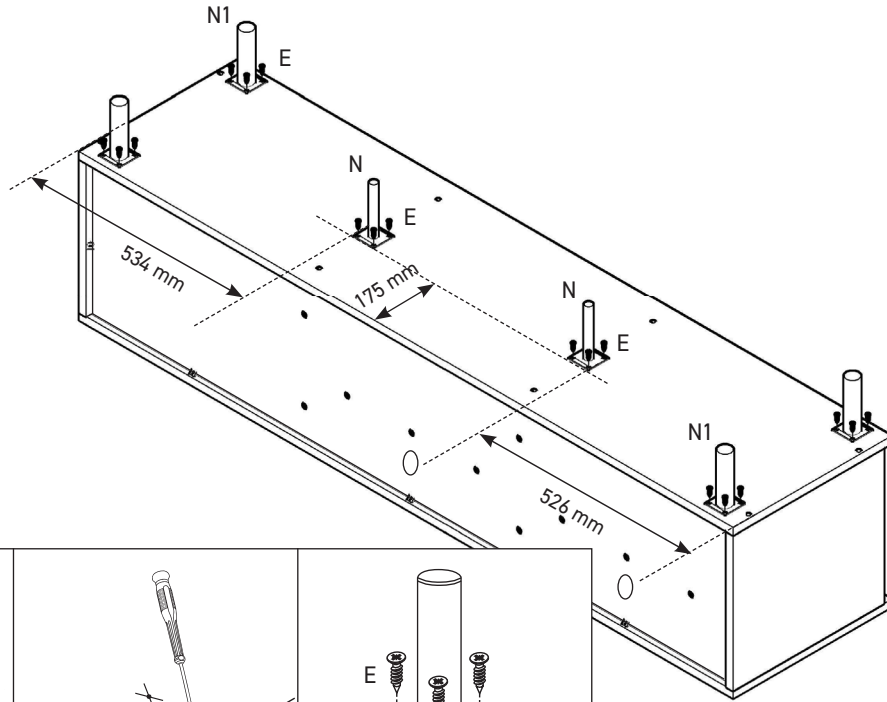

- E x24
3,5x13mm
- N x2
Ø18 / H=120mm
- N1 x4
Ø30 / H=120mm

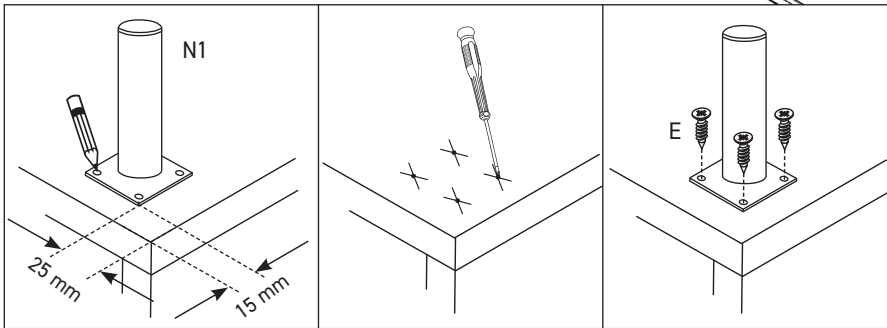

12

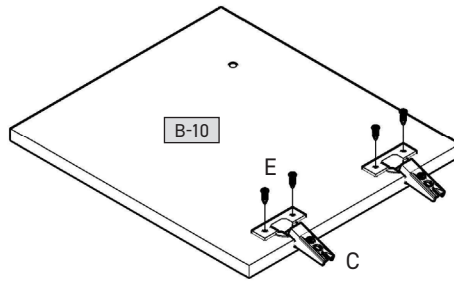
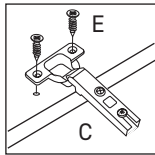

- C+D x2
- E x4
3,5x13mm

13

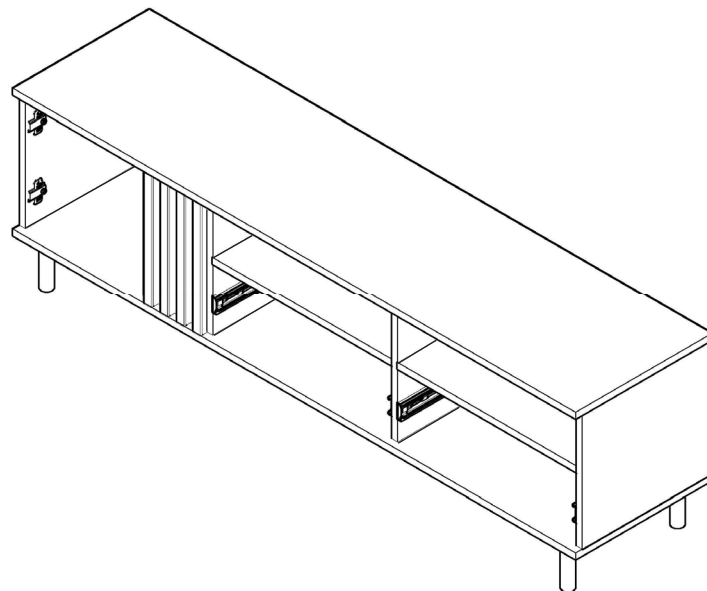
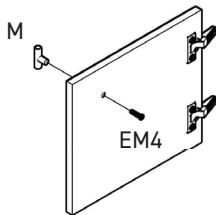

- EM4 x1
4x40mm
- M x1
GS10

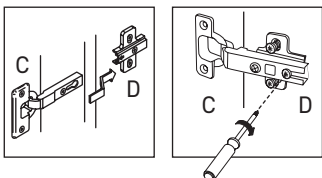

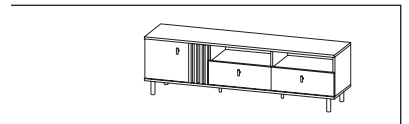

14

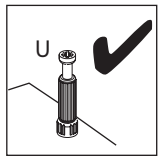
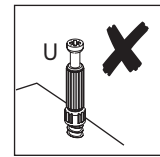
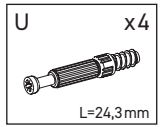
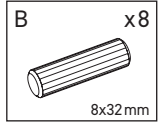
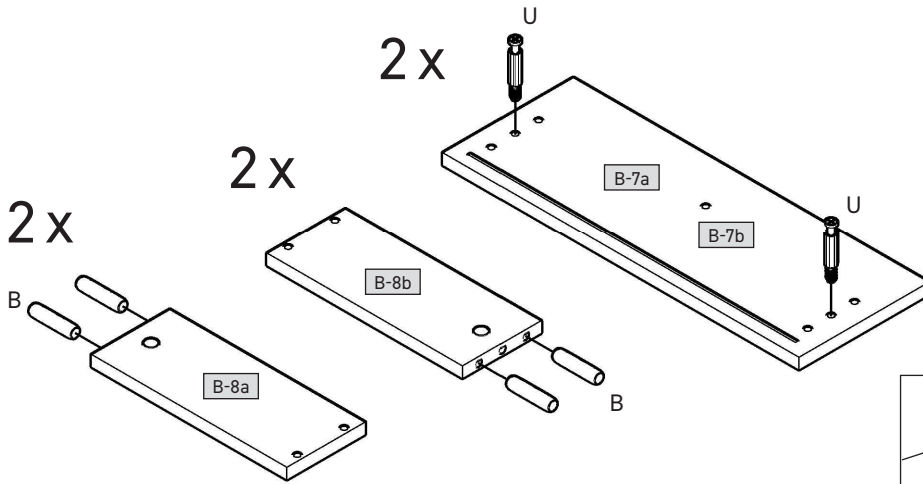

15

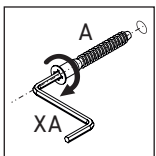
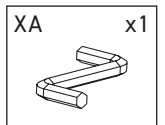
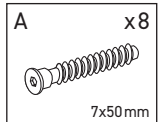
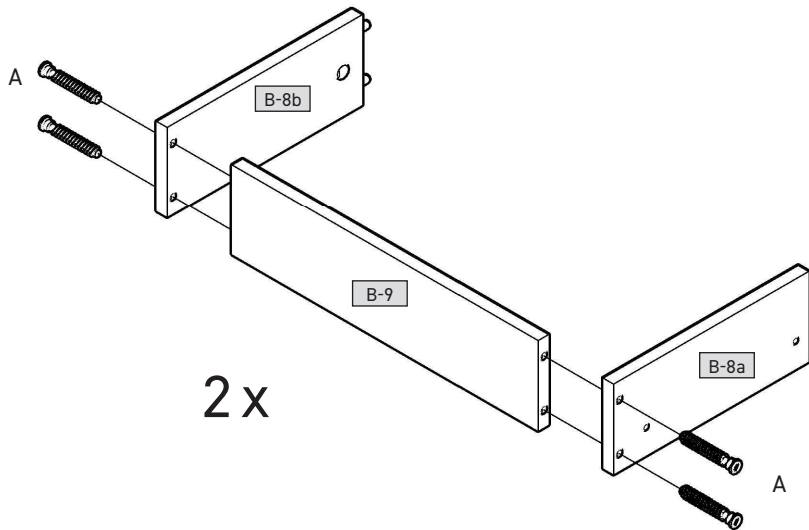

16

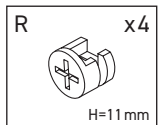
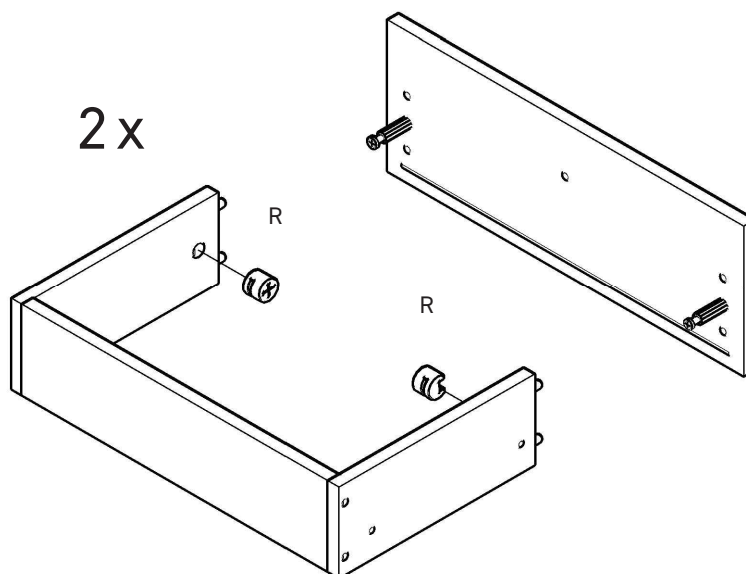
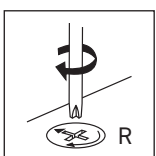
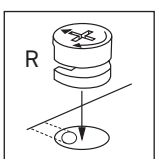

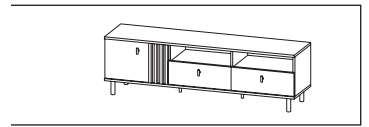

17

2 x

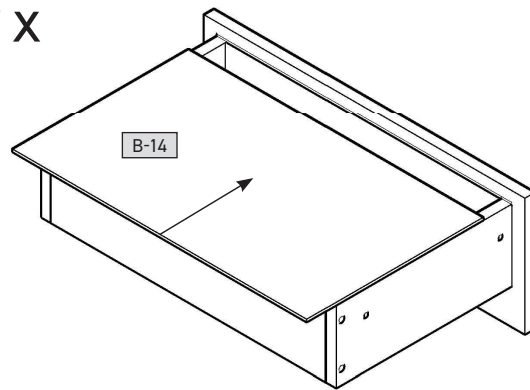

18

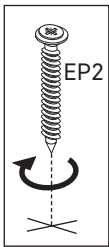

2 x

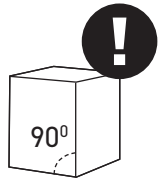
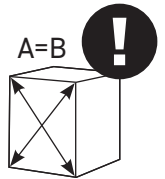
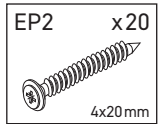
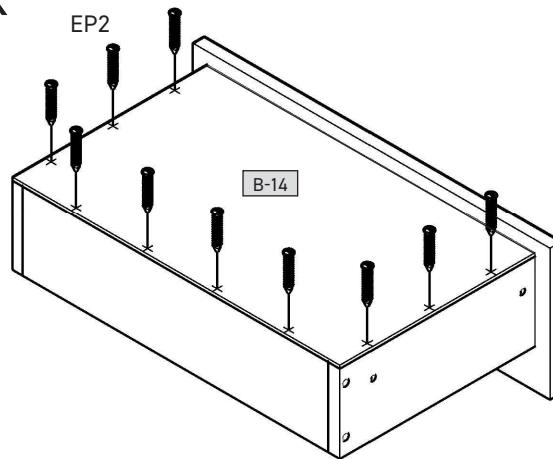

19



2 x

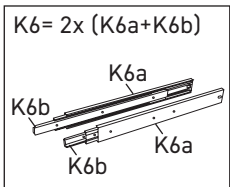
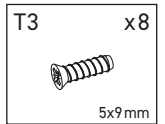
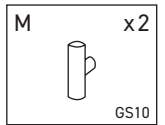
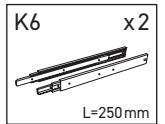
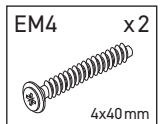
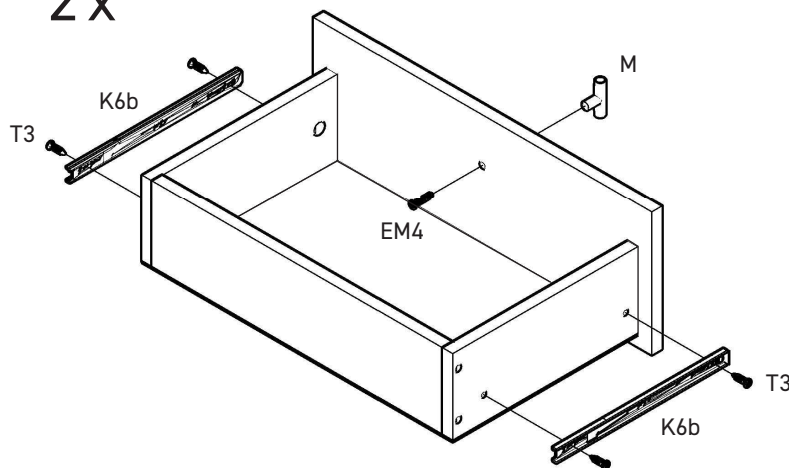

20

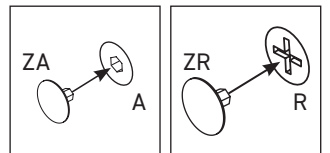
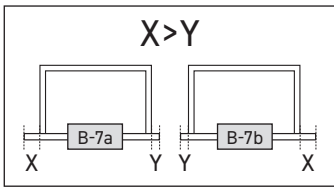
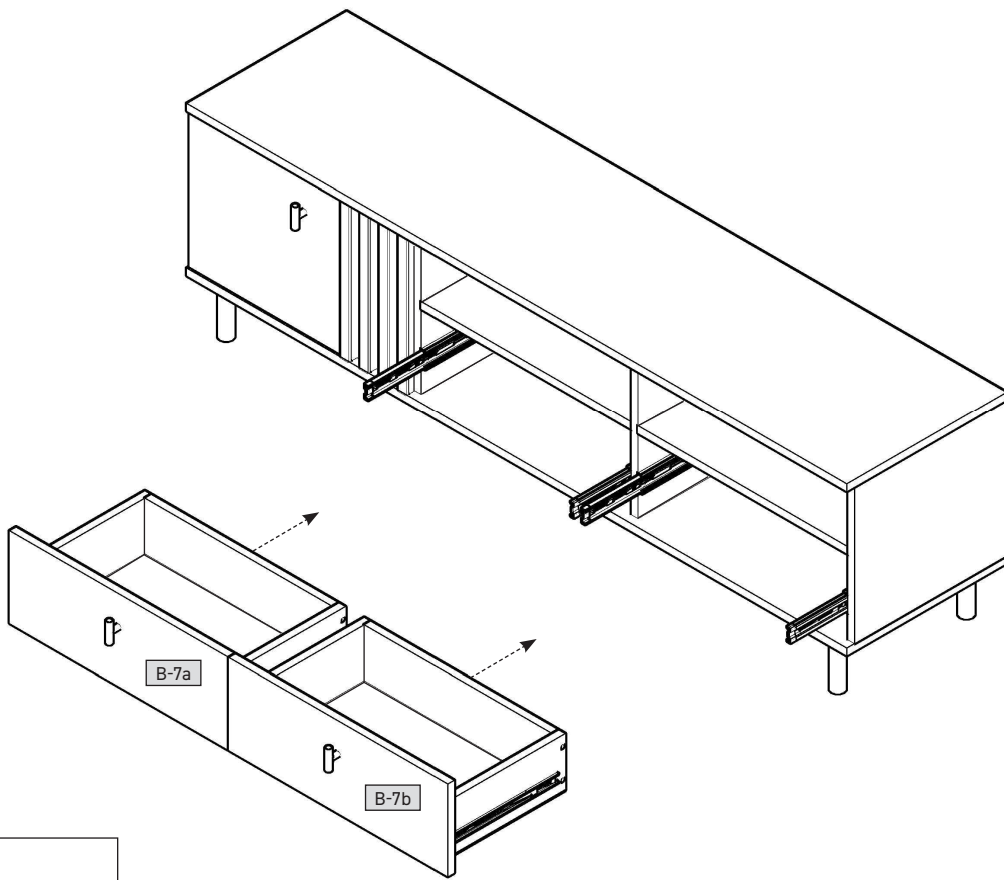
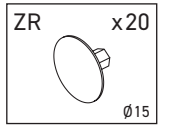
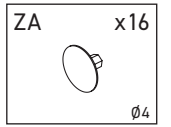
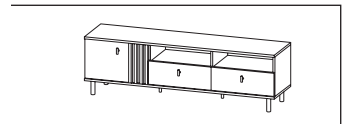
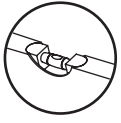

21

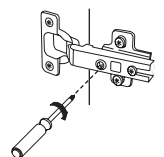
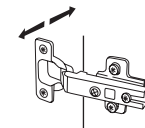
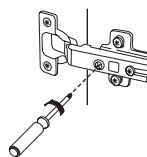
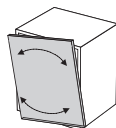
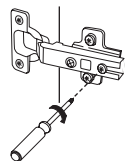
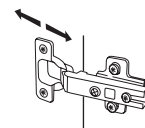
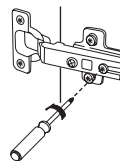
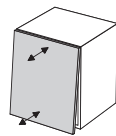
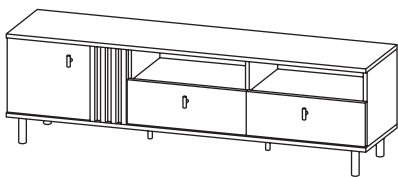
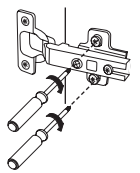
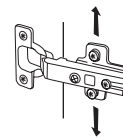
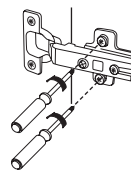
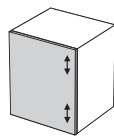

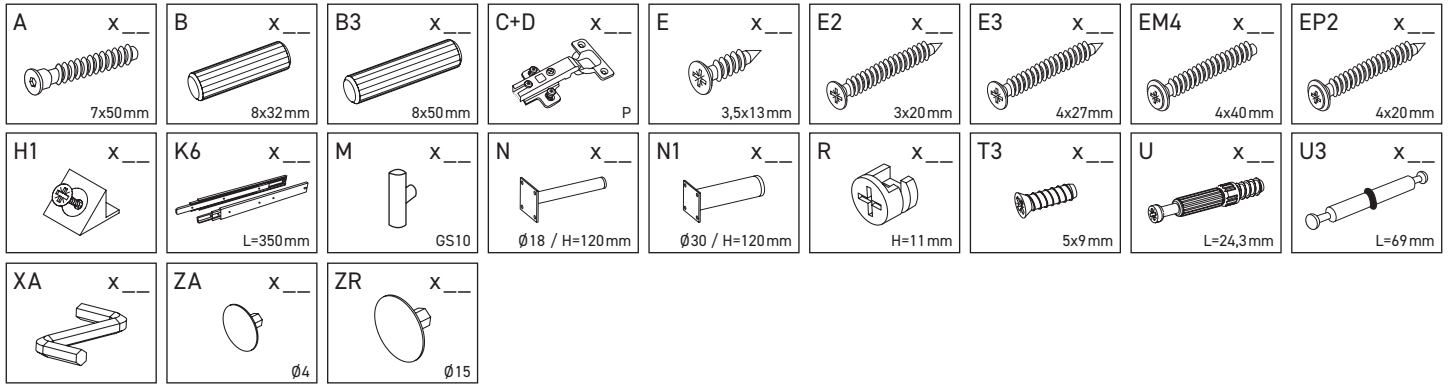

B-1a	1651	400	16	x 1	1/1
B-1b	1651	400	16	x 1	1/1
B-2	340	380	16	x 1	1/1
B-3	340	380	16	x 1	1/1
B-4	340	365	16	x 1	1/1
B-5	340	365	16	x 1	1/1
B-6	526	365	16	x 2	1/1
B-7a	547	200	16	x 1	1/1
B-7b	547	200	16	x 1	1/1
B-8a	350	120	16	x 1	1/1
B-8b	350	120	16	x 1	1/1
B-9	470	120	16	x 2	1/1
B-10	334	378	16	x 1	1/1
B-11	340	186	16	x 1	1/1
B-12	340	24	18	x 4	1/1
B-13	470	120	3	x 1	1/1
B-14	1632	684	3	x 1	1/1

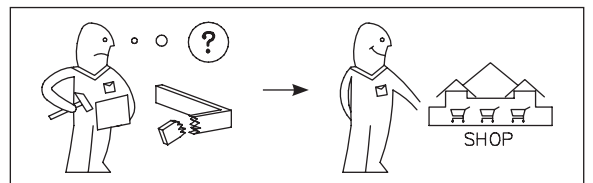
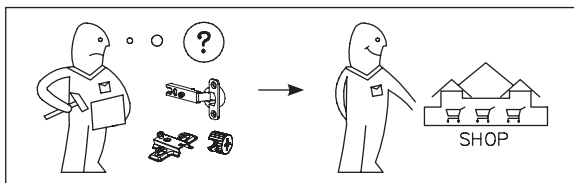
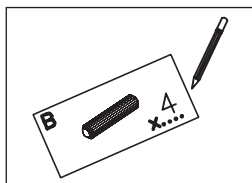
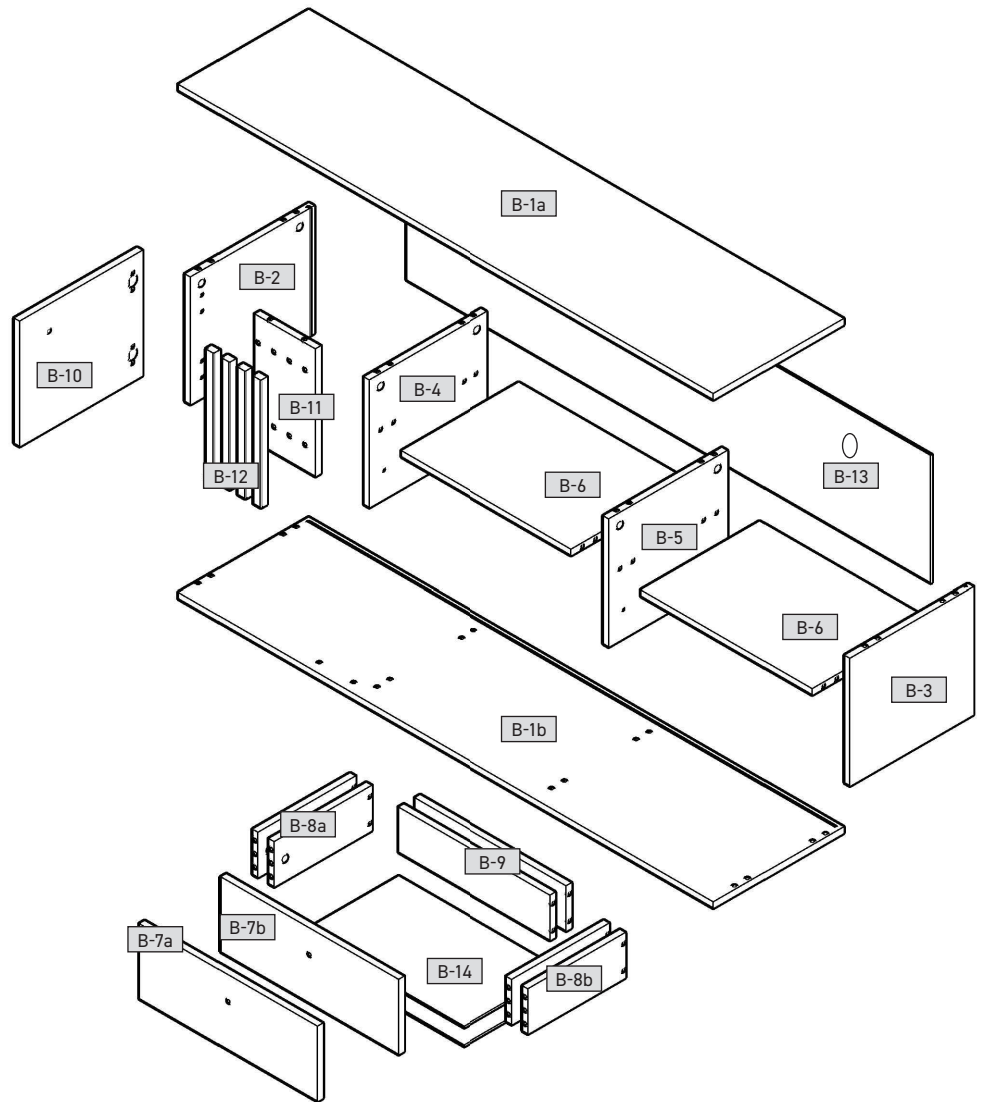

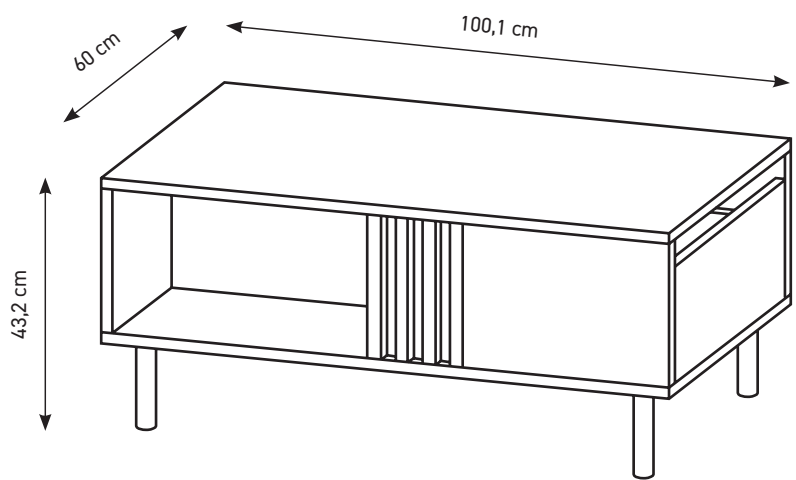

2022-07-22

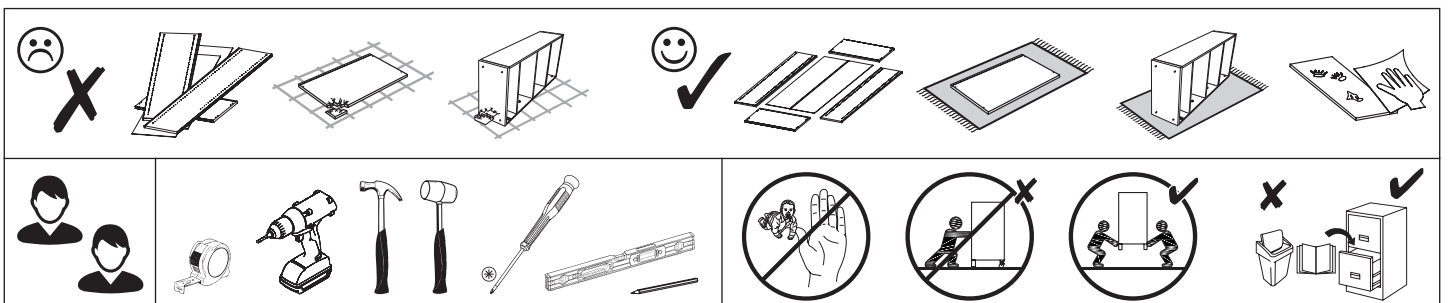

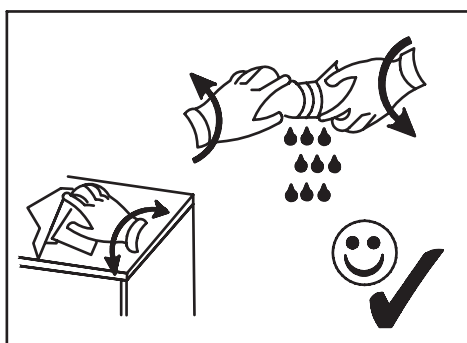
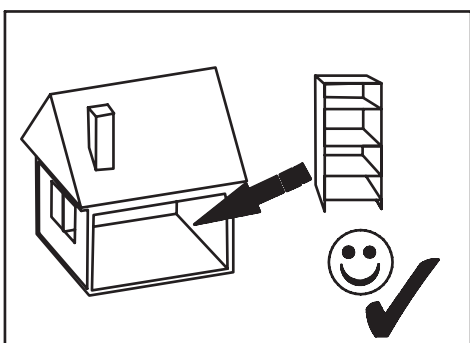
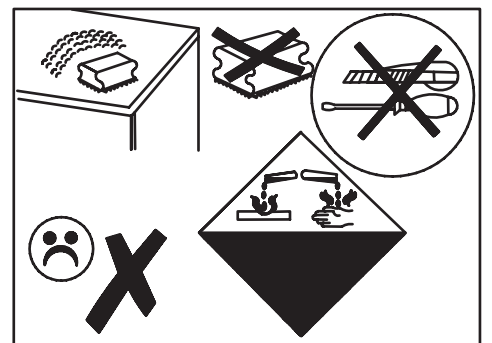
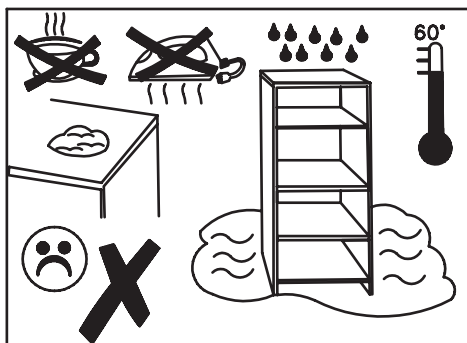
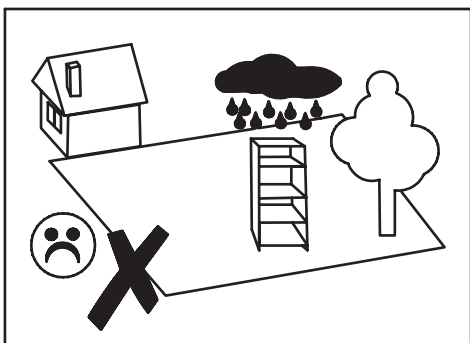
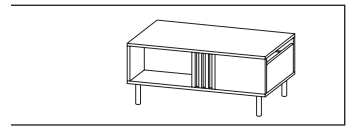

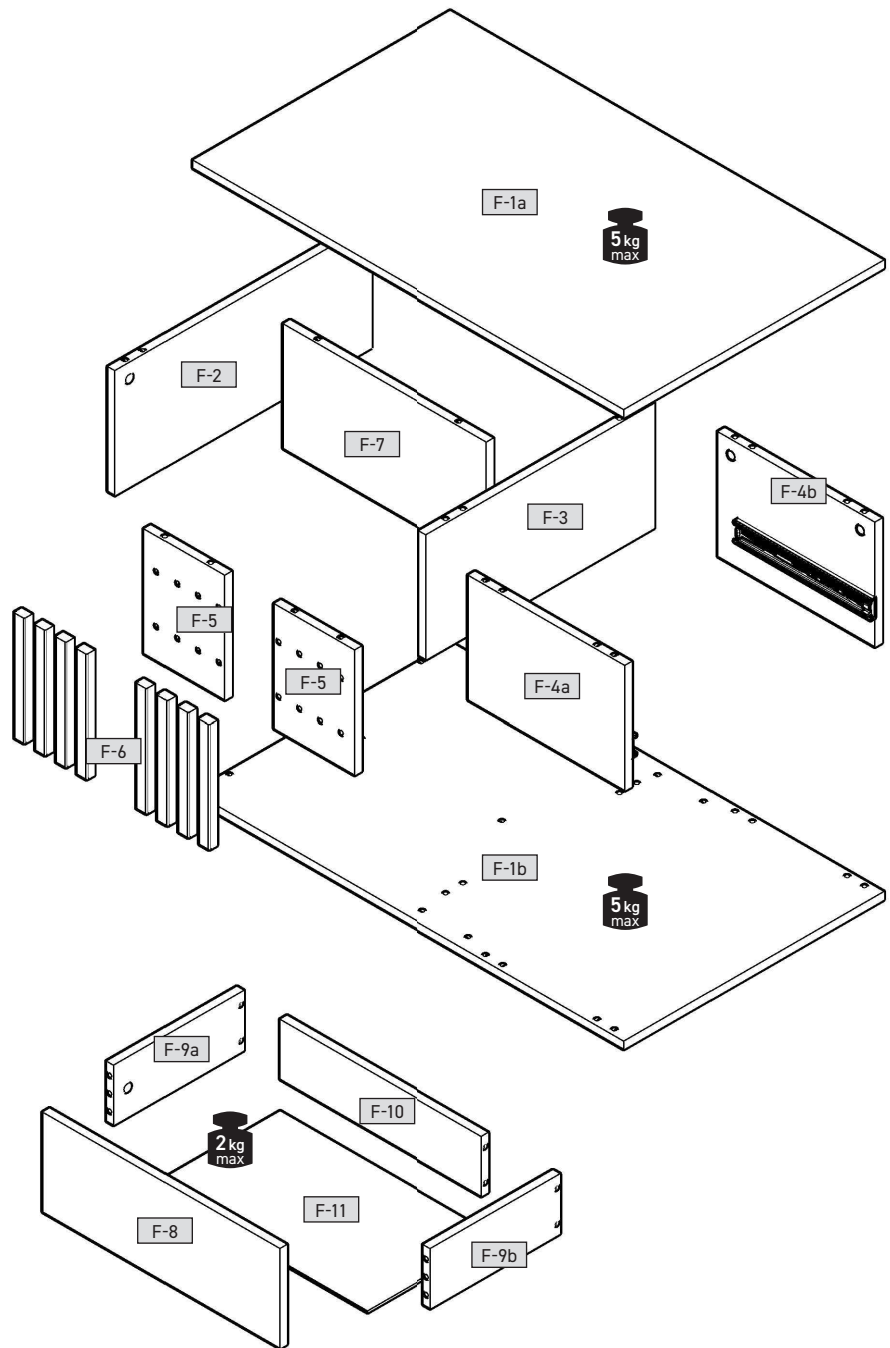
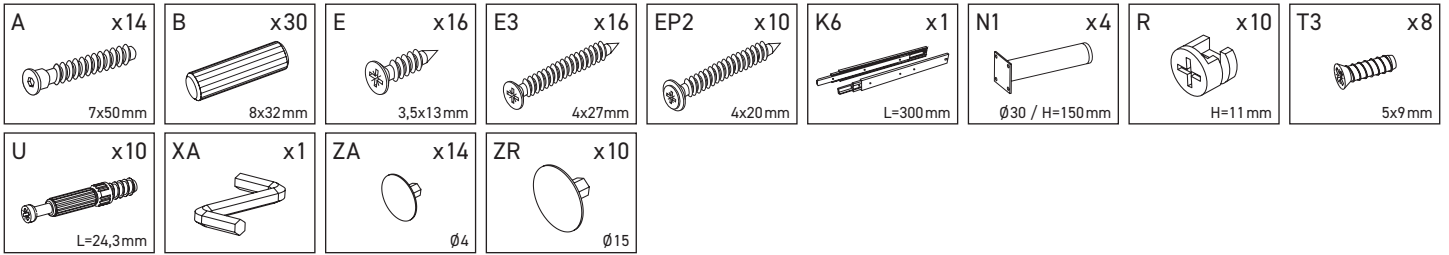
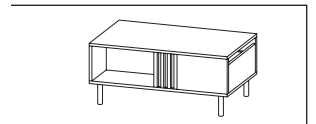

F-1a	1001	600	16	x 1	1/1
F-1b	1001	600	16	x 1	1/1
F-2	250	592	16	x 1	1/1
F-3	250	528	16	x 1	1/1
F-4a	250	363	16	x 1	1/1
F-4b	250	363	16	x 1	1/1
F-5	250	186	16	x 2	1/1
F-6	250	24	18	x 8	1/1
F-7	250	474	16	x 1	1/1
F-8	554	200	16	x 1	1/1
F-9a	300	120	16	x 1	1/1
F-9b	300	120	16	x 1	1/1
F-10	504	120	16	x 1	1/1
F-11	535	306	3	x 1	1/1

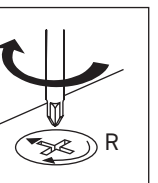
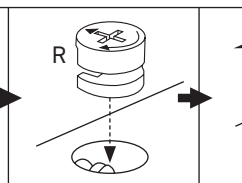
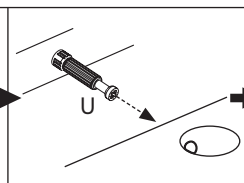
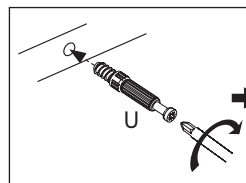
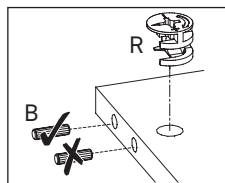
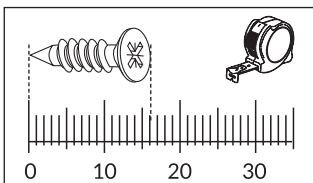

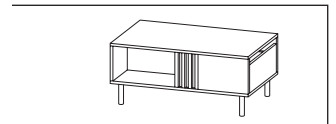

1

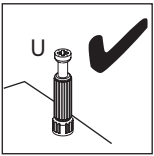
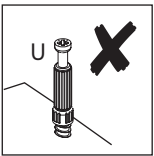
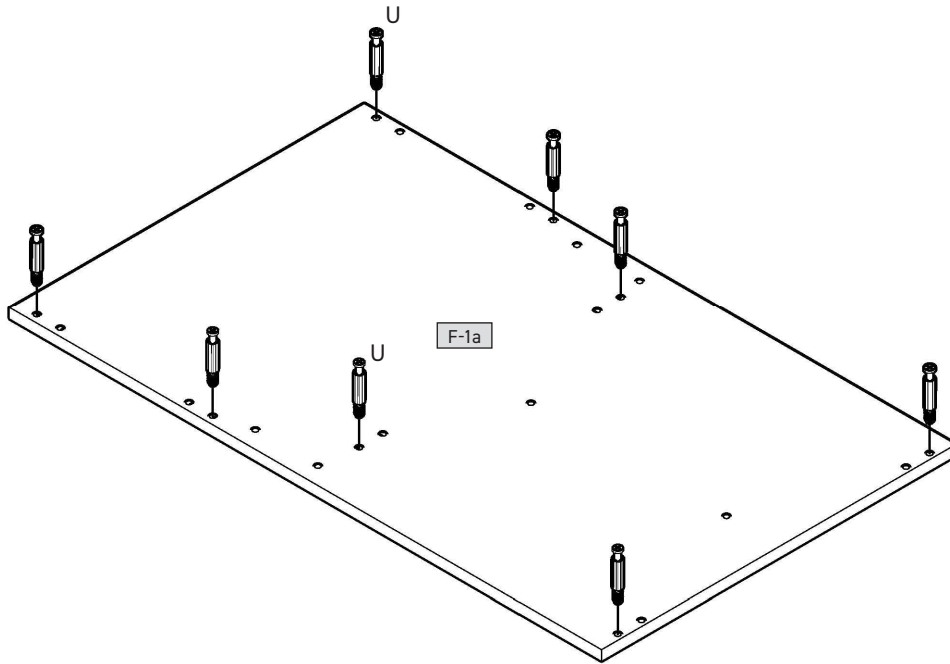
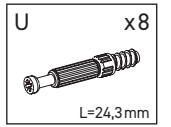

2

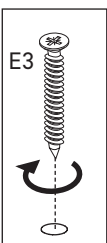
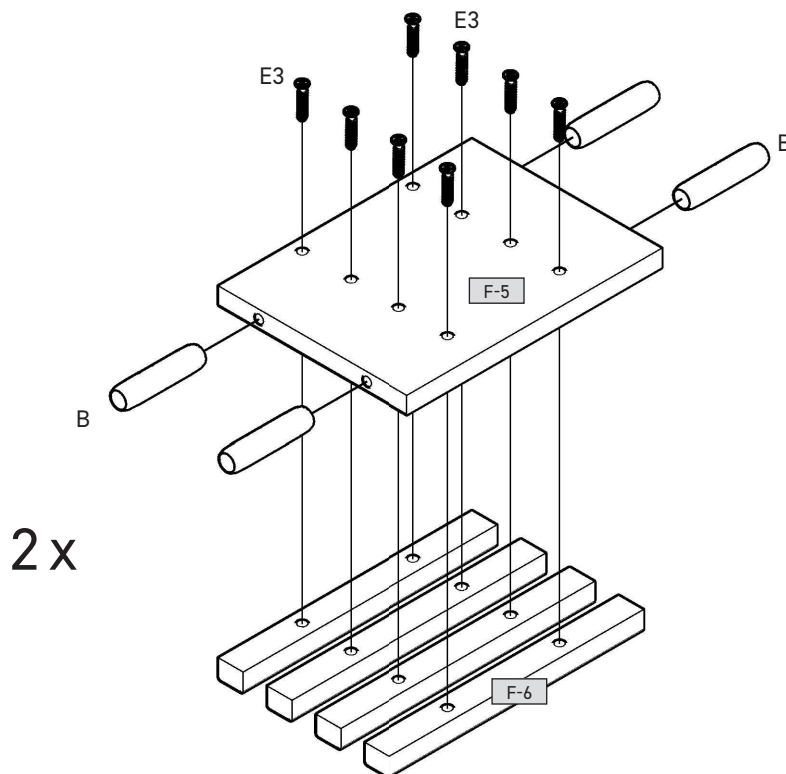
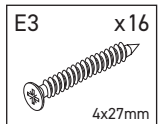
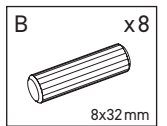

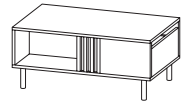

3

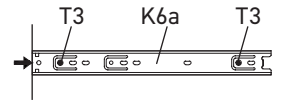
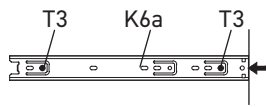
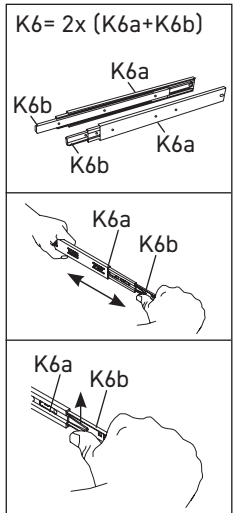
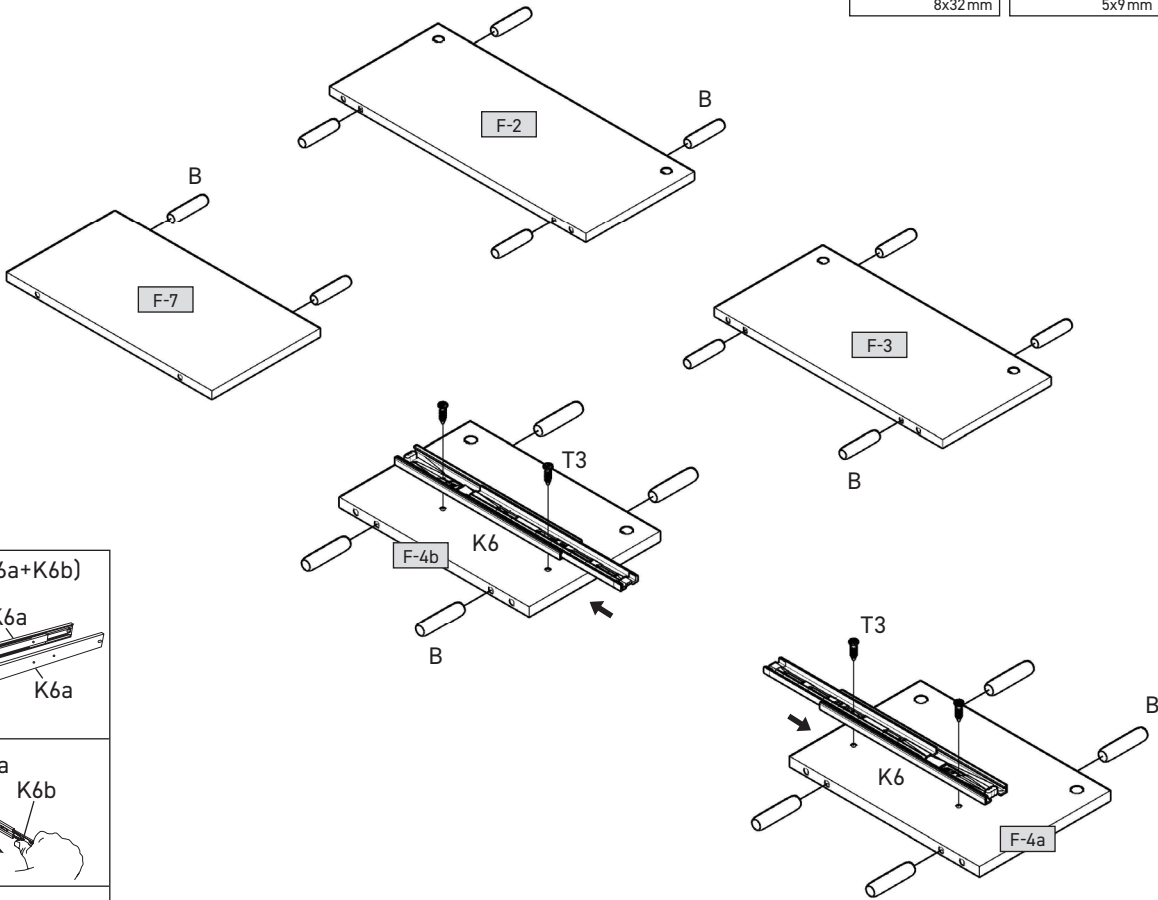
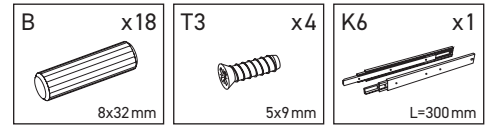

4

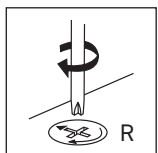
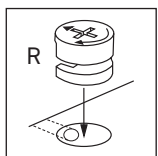
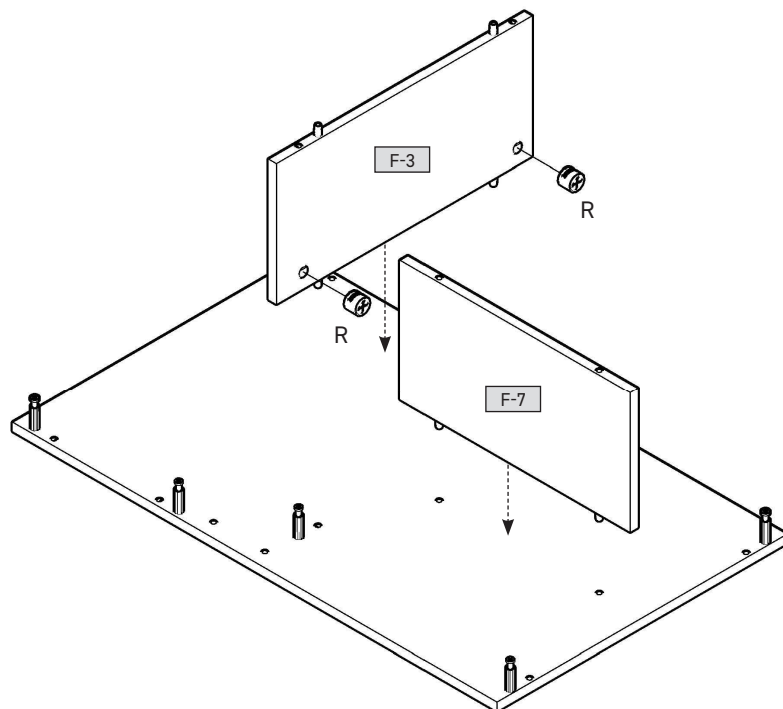
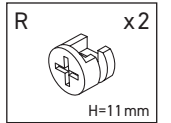

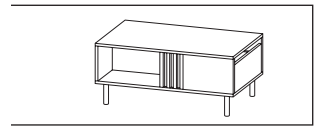

5

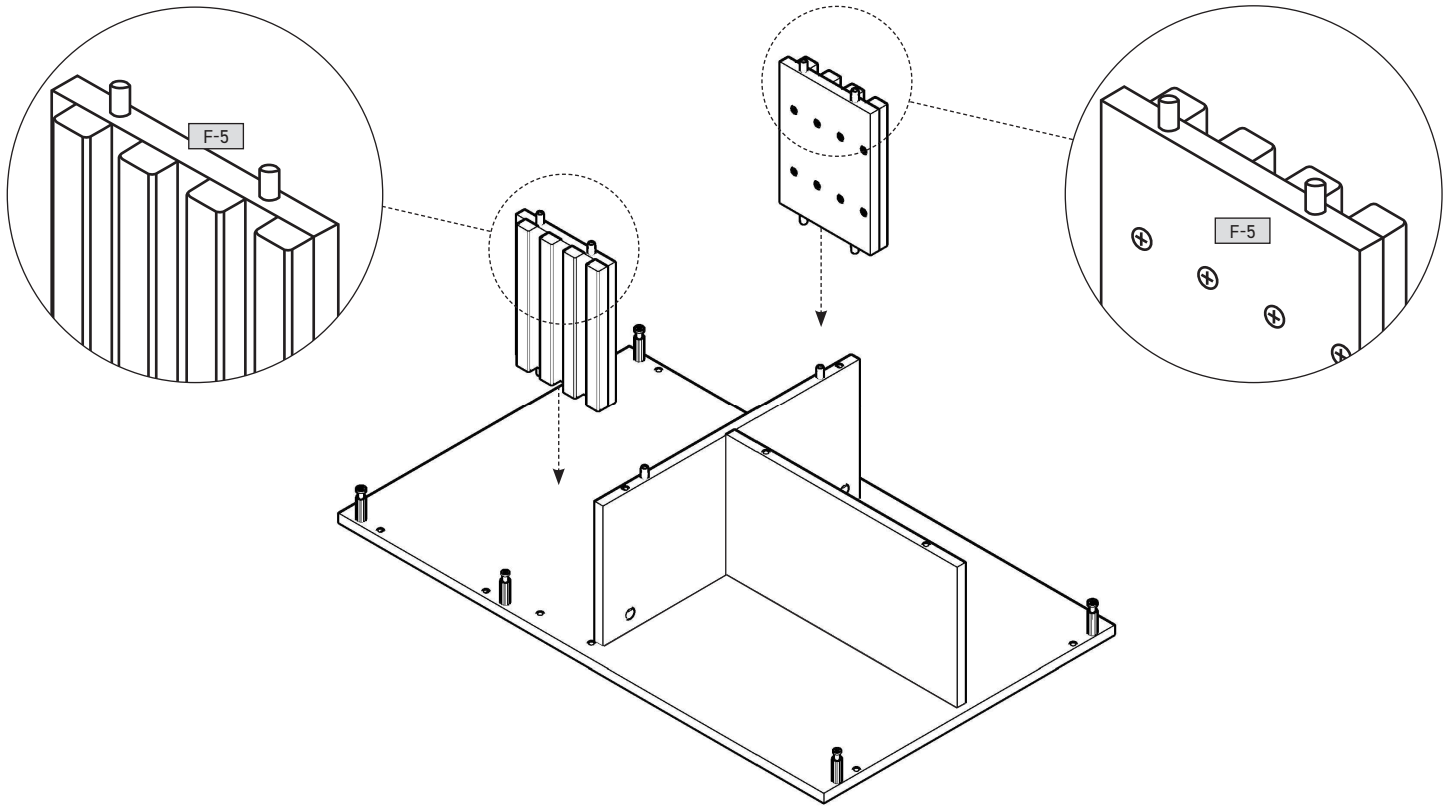

6

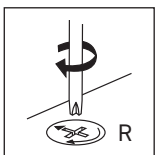
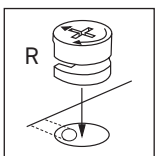
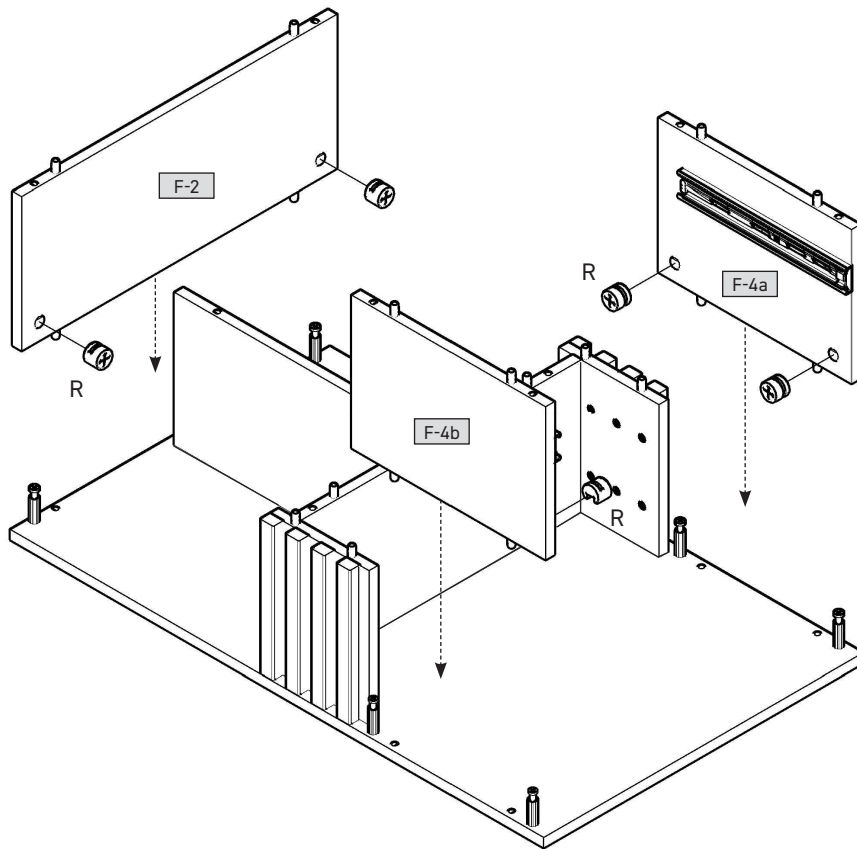
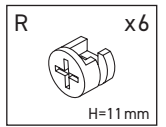

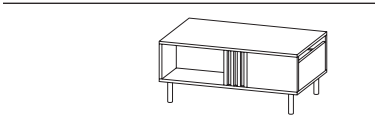

7

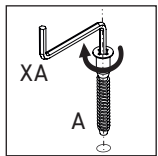
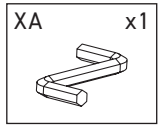
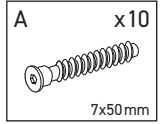
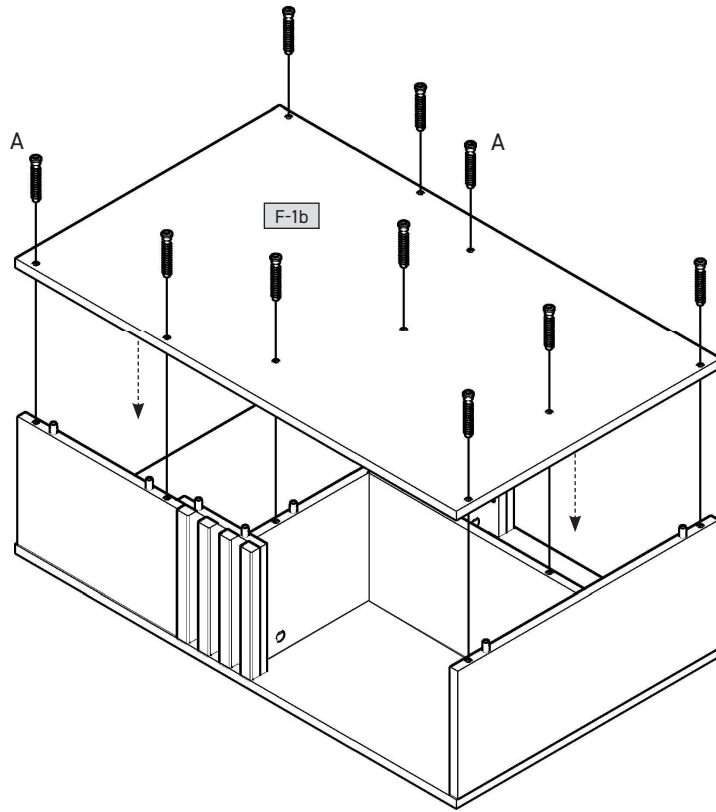

8

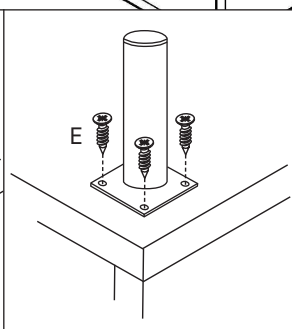
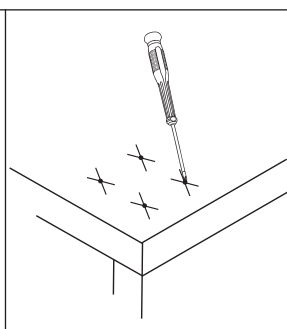
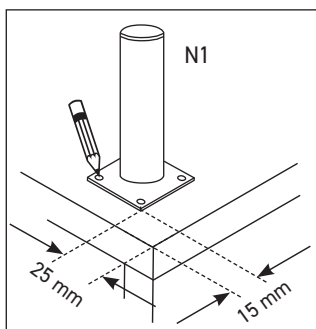
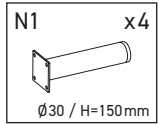
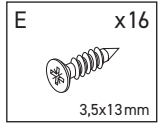
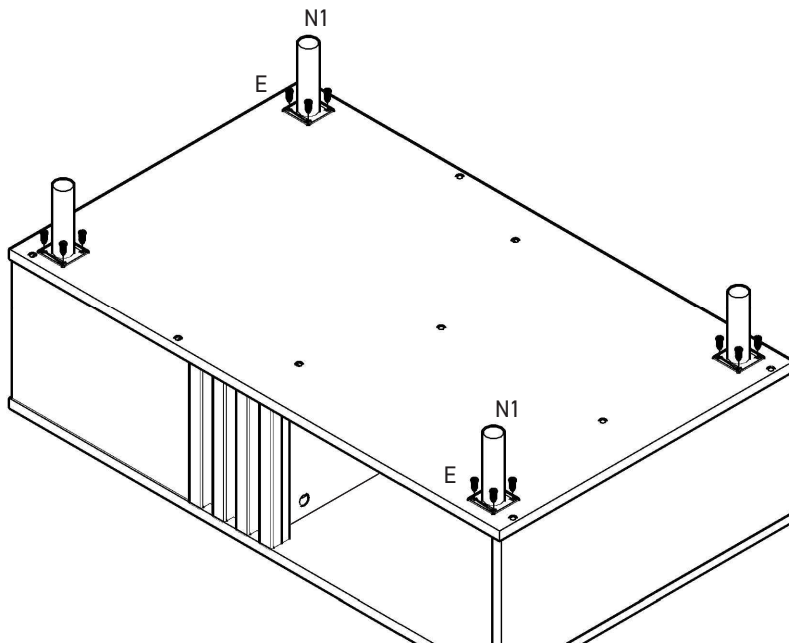
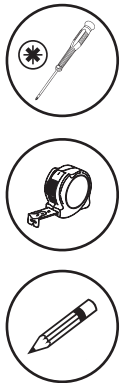

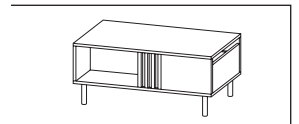

9

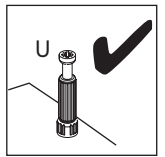
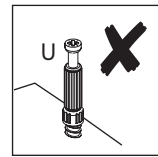
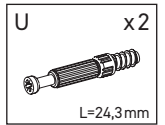
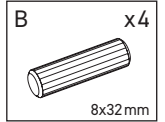
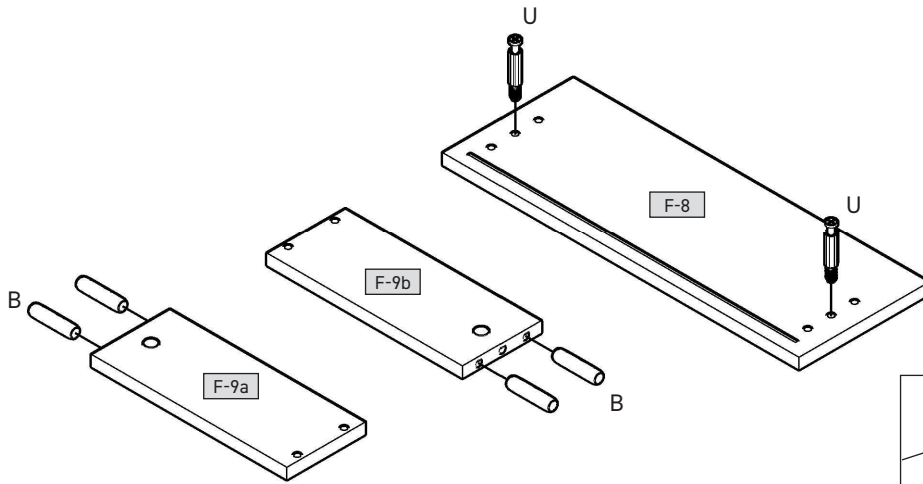

10

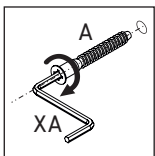
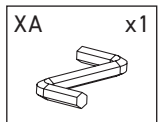
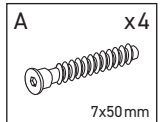
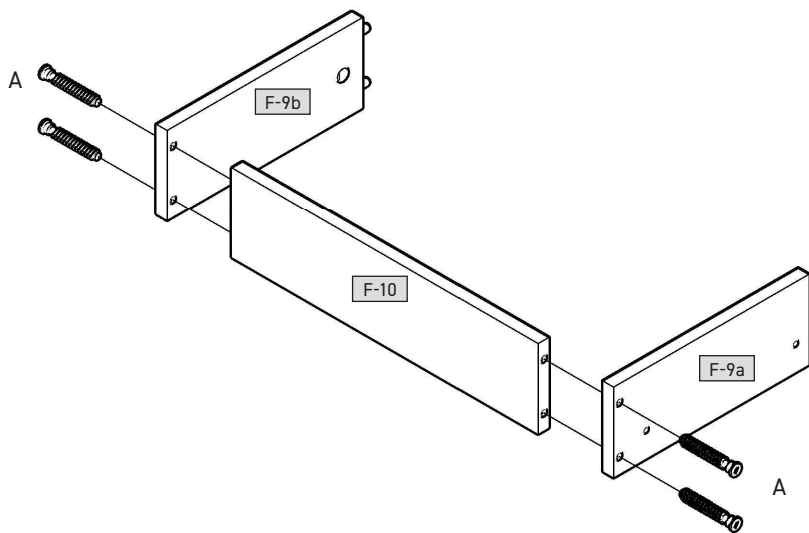

11

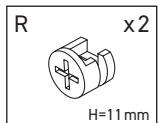
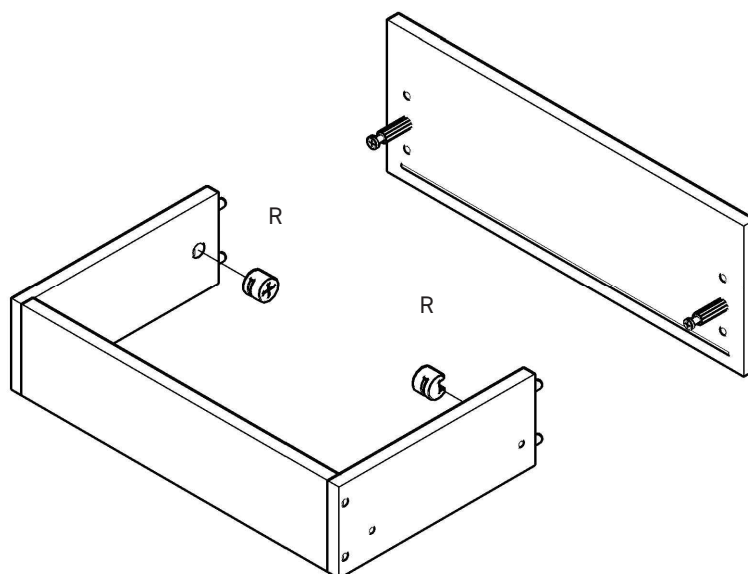
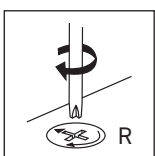
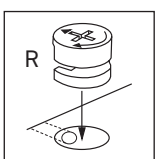

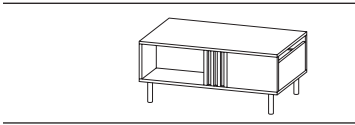

12

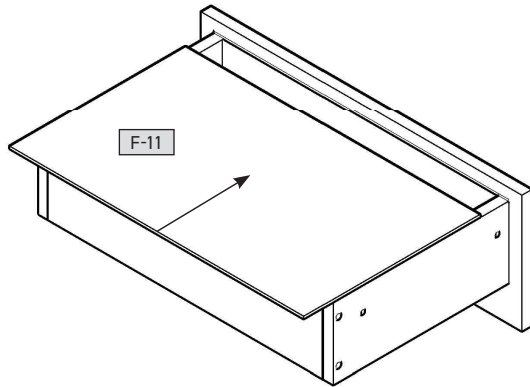

13

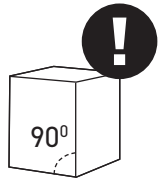
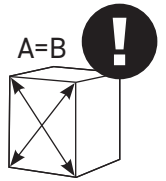
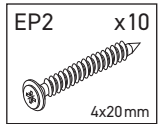
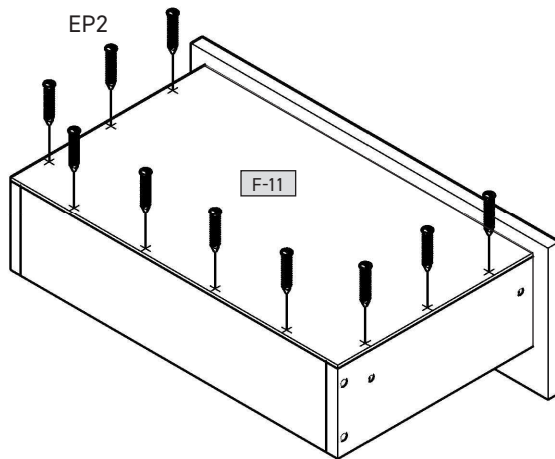
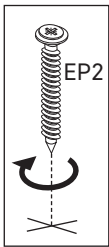

14

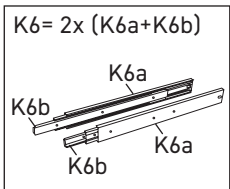
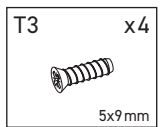
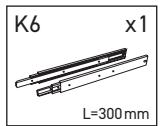
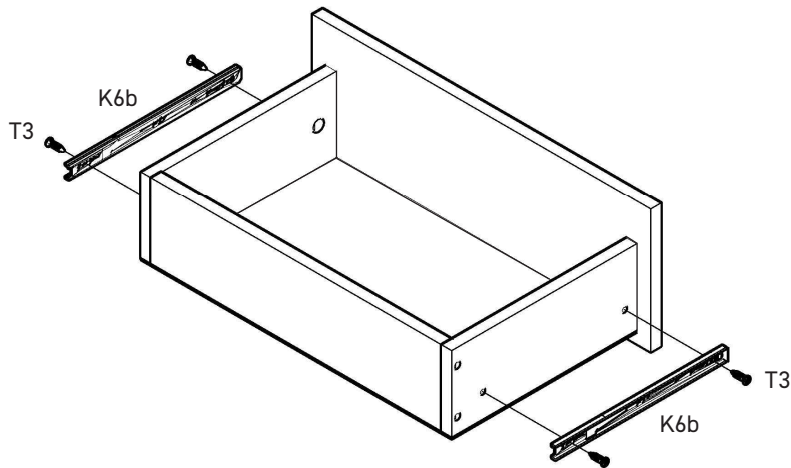

15

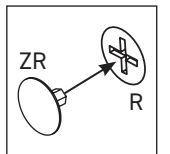
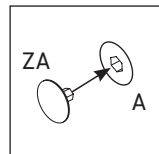
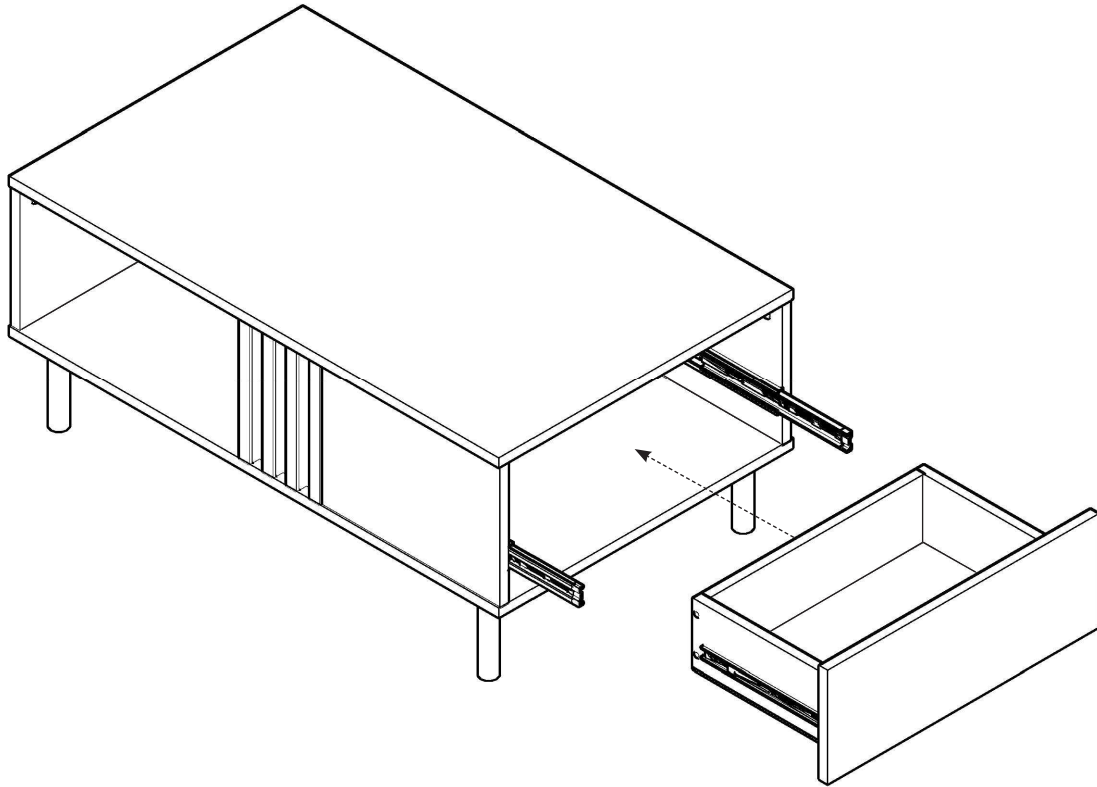
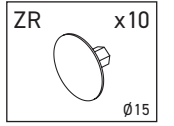
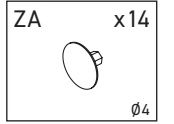
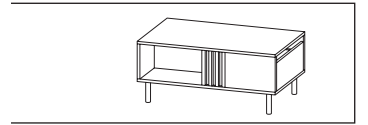
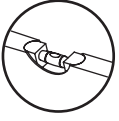

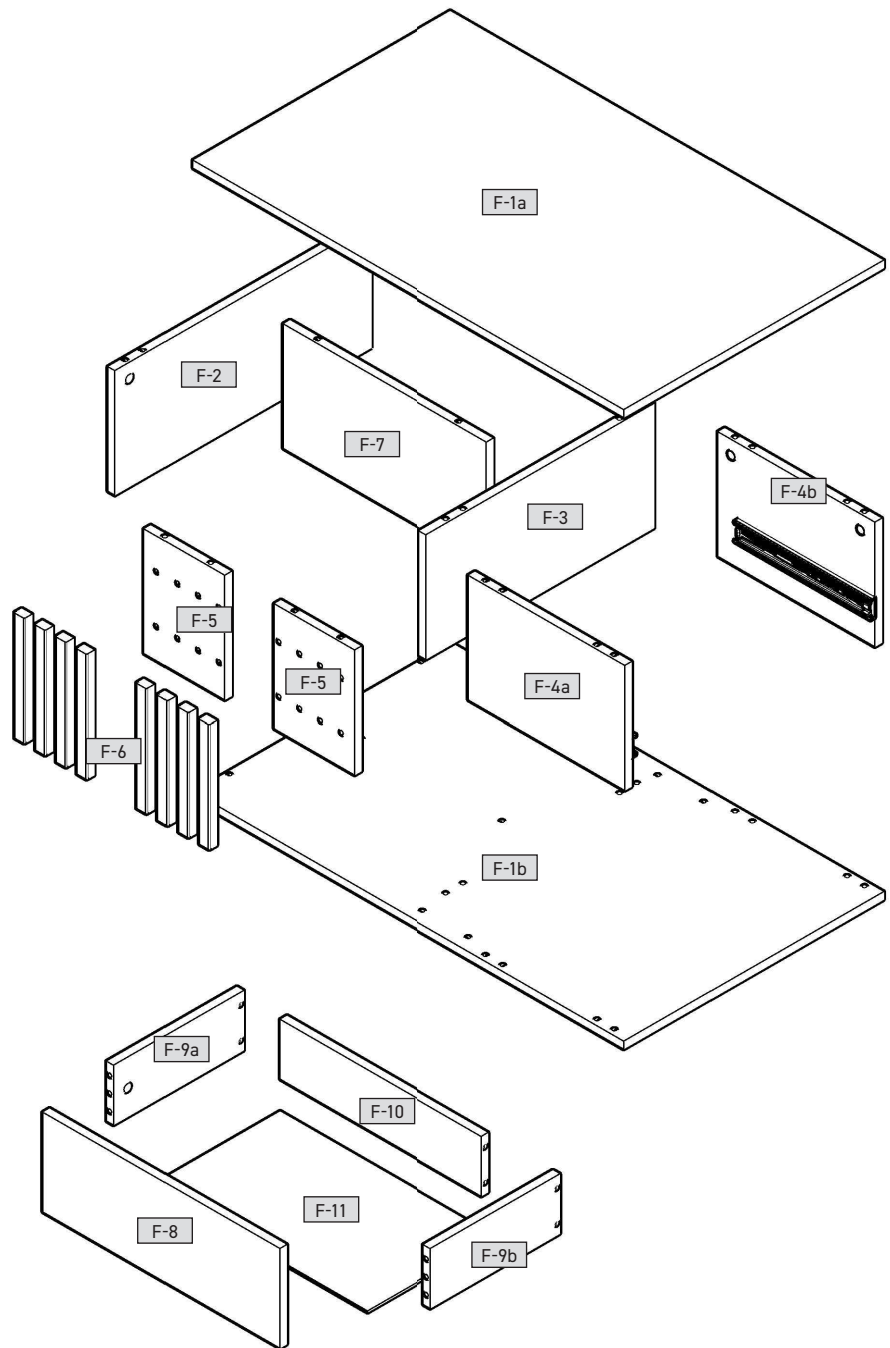
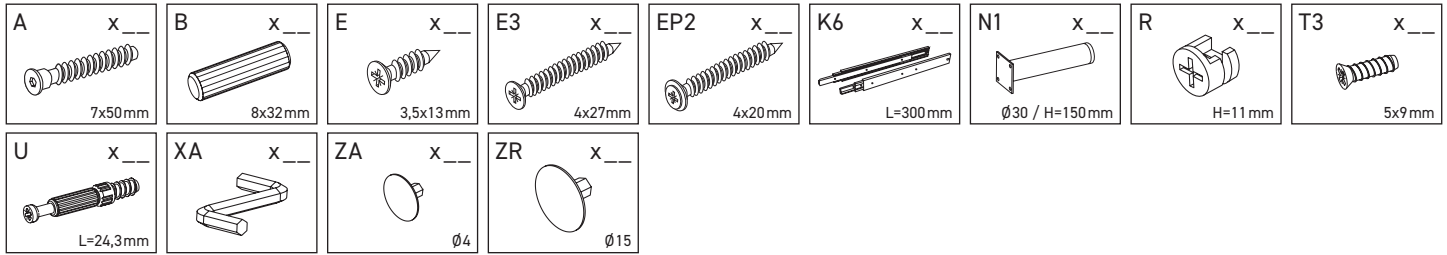

F-1a	1001	600	16	x 1	1/1
F-1b	1001	600	16	x 1	1/1
F-2	250	592	16	x 1	1/1
F-3	250	528	16	x 1	1/1
F-4a	250	363	16	x 1	1/1
F-4b	250	363	16	x 1	1/1
F-5	250	186	16	x 2	1/1
F-6	250	24	18	x 8	1/1
F-7	250	474	16	x 1	1/1
F-8	554	200	16	x 1	1/1
F-9a	300	120	16	x 1	1/1
F-9b	300	120	16	x 1	1/1
F-10	504	120	16	x 1	1/1
F-11	535	306	3	x 1	1/1

